

# SANICA

## Boru Fiyat Listesi

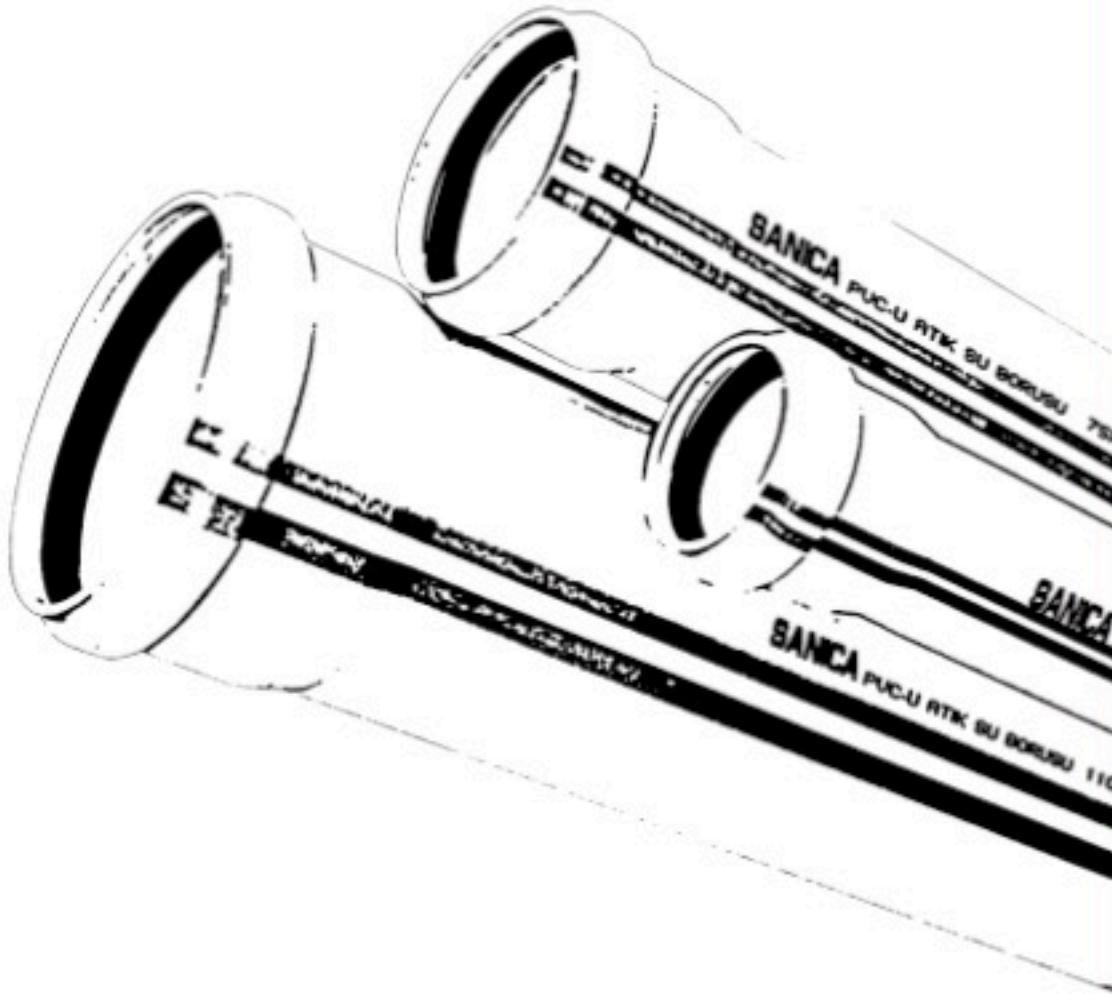

TÜRKİYE'NİN BORUSU



2018-5

# İÇİNDEKİLER

## INDEX



**SIHHİ TESİSAT BORULARI**  
SANITARY PIPES

**03**



**SIHHİ TESİSAT BORUSU  
EK PARÇALARI**  
SANITARY PIPE FITTINGS

**06**



**KOMBİ BAĞLANTI SETİ**  
GAS BOILER  
INSTALLATION SET

**15**



**BİNA İÇİ ISITMA SİSTEMLERİ  
ve EK PARÇALARI**  
INDOOR HEATING SYSTEMS and FITTINGS

**17**

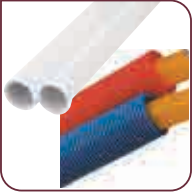

**PEX, AL-PEX, PERT BORULARI  
ve EK PARÇALARI**  
PEX, AL-PEX, PERT PIPES and FITTINGS

**18**

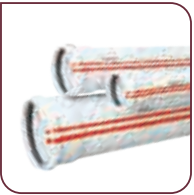

**ATIK SU BORULARI  
ve EK PARÇALARI**  
WASTE WATER PIPES and FITTINGS

**25**

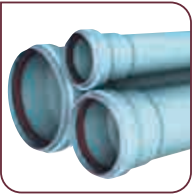

**SİLENZIO ATIK SU BORULARI  
ve EK PARÇALARI**  
SILENZIO WASTE WATER PIPES and FITTINGS

**38**



**SÜPER SESSİZ ATIK SU BORULARI  
ve EK PARÇALARI**  
SUPER SILENT WASTE WATER PIPES and FITTINGS

**48**



**ALTYAPI SİSTEMLERİ (PE)**  
(PE) INFRASTRUCTURE SYSTEMS

**52**



**PVC BASINÇLI TEMİZ SU BORULARI**  
PVC PRESSURE CLEAN WATER PIPES

**58**



**KORUGE KANALİZASYON BORULARI  
ve EK PARÇALARI**  
CORRUGATED SEWER PIPES and FITTINGS

**61**

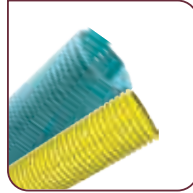

**DRENAJ BORULARI**  
DRAINAGE PIPES

**66**

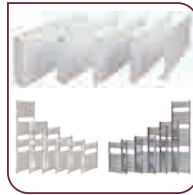

**RADYATÖRLER ve HAVLU PANELLER**  
RADIATORS and TOWEL WARMERS

**68**



**SERTİFİKALAR**  
CERTIFICATES

**71**

**SANICA**

# Boru Pipe

## SIHHİ TESİSAT BORULARI SANITARY PIPES



PPR-C BORULAR  
PPR-C PIPES

PPR-C BORU PN 16  
PPR-C PIPE PN 16

Beyaz White	Kod Code		Çap Diameter (mm)	Paket Miktarı Bundle Quantity (m)	Paket Ebatı Bundle Dimension (cm)	Paket Ağırlığı Bundle Weight (kg)	Fiyat Price (TL)
	Yeşil Green	Gri Grey					
502-600200	700200	800200	40x3.7	40	11x21x400	21.86	21,34
502-600202	700202	800202	50x4.6	20	15.5x10.5x400	17.20	32,76
502-600204	700204	800204	63x5.8	16	25x7x400	21.56	51,95
502-600206	700206	800206	75x6.8	12	8x22x400	23.03	73,68
502-600208	700208	800208	90x8.2	8	9.5x18x400	22.03	112,41
502-600210	700210	800210	110x10	4	11.5x11.5x400	16.59	181,44
502-600212	700212	800212	125x11.4	4	12.5x12.5x400	21.27	225,50



Not: İstenirse siyah U.V. katkı olarak üretilebilir.

Note: Available with black U.V. Additive upon request.

PPR-C BORU PN 20  
PPR-C PIPE PN 20

Beyaz White	Kod Code		Çap Diameter (mm)	Paket Miktarı Bundle Quantity (m)	Paket Ebatı Bundle Dimension (cm)	Paket Ağırlığı Bundle Weight (kg)	Fiyat Price (TL)
	Yeşil Green	Gri Grey					
502-600250	700250	800250	20x2.8	100	7x18.5x400	14.00	5,88
502-600252	700252	800252	25x3.5	80	8x18x400	17.42	9,96
502-600254	700254	800254	32x4.4	60	10x19x400	21.00	17,30
502-600256	700256	800256	40x5.5	40	11x21x400	21.86	27,52
502-600258	700258	800258	50x6.9	20	15.5x10.5x400	17.20	43,29
502-600260	700260	800260	63x8.6	16	25x7x400	21.56	69,45
502-600262	700262	800262	75x10.3	12	8x22x400	23.03	99,79
502-600264	700264	800264	90x12.3	8	9.5x18x400	22.03	156,26
502-600266	700266	800266	110x15.1	4	11.5x11.5x400	16.59	237,21
502-600268	700268	800268	125x17.1	4	12.5x12.5x400	21.27	305,01



Not: İstenirse siyah U.V. katkı olarak üretilebilir.

Note: Available with black U.V. Additive upon request.

PPR-C BORU PN 25  
PPR-C PIPE PN 25

Beyaz White	Kod Code		Çap Diameter (mm)	Paket Miktarı Bundle Quantity (m)	Paket Ebatı Bundle Dimension (cm)	Paket Ağırlığı Bundle Weight (kg)	Fiyat Price (TL)
	Yeşil Green	Gri Grey					
502-600300	700300	800300	20x3.4	100	7x18.5x400	16.30	6,38
502-600302	700302	800302	25x4.2	80	8x18x400	20.14	10,10
502-600304	700304	800304	32x5.4	60	10x19x400	24.78	18,83
502-600306	700306	800306	40x6.7	40	11x21x400	25.66	29,64
502-600308	700308	800308	50x8.3	20	15.5x10.5x400	20.28	47,04
502-600310	700310	800310	63x10.5	16	25x7x400	25.36	77,94
502-600312	700312	800312	75x12.5	12	8x22x400	26.94	110,49
502-600314	700314	800314	90x15	8	9.5x18x400	25.88	188,04
502-600316	700316	800316	110x18.3	4	11.5x11.5x400	19.38	287,98
502-600318	700318	800318	125x20.8	4	12.5x12.5x400	24.94	364,39



Not: İstenirse siyah U.V. katkı olarak üretilebilir.

Note: Available with black U.V. Additive upon request.



CAM ELYAF TAKVİYELİ BORULAR  
GLASS FIBER REINFORCED PIPES

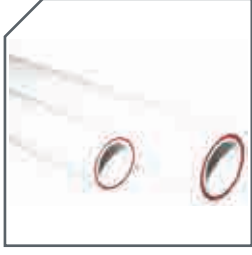

CAM ELYAFLI PPR-C BORULAR PN 20 (Kompozit Borular)

GLASS FIBER REINFORCED PIPE PN 20 (Composite Pipes)

Beyaz White	Kod Code		Çap Diameter (mm)	Paket Miktarı Bundle Quantity (m)	Paket Ebatı Bundle Dimension (cm)	Paket Ağırlığı Bundle Weight (kg)	Fiyat Price (TL)
	Yeşil Green	Gri Grey					
502-600400	700400	800400	20x2.8	100	7x18.5x400	16.00	7,46
502-600402	700402	800402	25x3.5	80	8x18x400	19.98	10,52
502-600404	700404	800404	32x4.4	60	10x19x400	24.12	17,80
502-600406	700406	800406	40x5.5	40	11x21x400	25.10	27,75
502-600408	700408	800408	50x6.9	20	15.5x10.5x400	19.72	43,07
502-600410	700410	800410	63x8.6	16	25x7x400	24.75	73,82
502-600412	700412	800412	75x10.3	12	8x22x400	26.41	103,05
502-600414	700414	800414	90x12.3	8	9.5x18x400	25.27	167,65
502-600416	700416	800416	110x15.1	4	11.5x11.5x400	19.02	270,13
502-600418	700418	800418	125x17.1	4	12.5x12.5x400	24.40	410,75

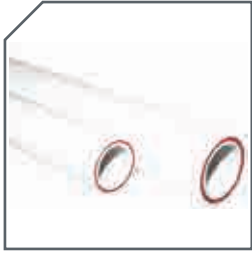

CAM ELYAFLI PPR-C BORULAR PN 25 (Kompozit Borular)

GLASS FIBER REINFORCED PIPE PN 25 (Composite Pipes)

Beyaz White	Kod Code		Çap Diameter (mm)	Paket Miktarı Bundle Quantity (m)	Paket Ebatı Bundle Dimension (cm)	Paket Ağırlığı Bundle Weight (kg)	Fiyat Price (TL)
	Yeşil Green	Gri Grey					
502-600350	700350	800350	20x3.4	100	7x18.5x400	18.30	7,94
502-600352	700352	800352	25x4.2	80	8x18x400	22.38	11,53
502-600354	700354	800354	32x5.4	60	10x19x400	27.48	20,73
502-600356	700356	800356	40x6.7	40	11x21x400	29.46	32,60
502-600358	700358	800358	50x8.3	20	15.5x10.5x400	22.90	52,12
502-600360	700360	800360	63x10.5	16	25x7x400	29.10	82,57
502-600362	700362	800362	75x12.5	12	8x22x400	30.91	124,59
502-600364	700364	800364	90x15.0	8	9.5x18x400	29.69	199,81
502-600366	700366	800366	110x18.3	4	11.5x11.5x400	22.32	324,56
502-600368	700368	800368	125x20.8	4	12.5x12.5x400	28.72	479,31

ALÜMİNYUM FOLYOLU PPR-C BORULAR  
ALUMINIUM FOILED PPR-C PIPES



KOMBİ BORUSU PPR-C (Ortadan Alüminyum Folyolu)

PPR-C COMBI PIPE (Aluminium Foil Located in Middle)

Beyaz White	Kod Code		Çap Diameter (mm)	Paket Miktarı Bundle Quantity (m)	Paket Ebatı Bundle Dimension (cm)	Paket Ağırlığı Bundle Weight (kg)	Fiyat Price (TL)
	Yeşil Green	Gri Grey					
502-630100	730100	830100	20x3.4	100	7x18.5x400	17.70	9,24
502-630102	730102	830102	25x4.2	80	8x18x400	21.50	13,02
502-630104	730104	830104	32x5.4	60	10x19x400	25.98	22,30
502-630106	730106	830106	40x6.7	40	11x21x400	26.62	36,13
502-630108	730108	830108	50x8.3	20	15.5x10.5x400	20.54	52,75
502-630110	730110	830110	63x10.5	16	25x7x400	25.93	86,42

# BORU PIPE



**SIHHİ TESİSAT BORUSU EK PARÇALARI**  
**SANITARY PIPE FITTINGS**



DİRSEK 90°  
90° ELBOW

Beyaz White	Kod Code		Çap Diameter (mm)	Paket Miktarı Box Quantity (pcs)	Paket Ebatı Box Dimension (cm)	Paket Ağırlığı Box Weight (kg)	Fiyat Price (TL)
	Yeşil Green	Gri Grey					
502-600452	700452	800452	20	400	20x40x40	6.295	0,81
502-600454	700454	800454	25	250	20x40x40	6.230	1,32
502-600456	700456	800456	32	150	20x40x40	7.023	2,31
502-600458	700458	800458	40	80	20x40x40	7.527	4,99
502-600460	700460	800460	50	50	20x40x40	7.480	9,05
502-600462	700462	800462	63	25	20x40x40	7.793	18,41
702-600464	700464	800464	75	12	20x40x40	5.530	38,16
702-600466	700466	800466	90	8	20x40x40	6.788	63,46
502-600468	700468	800468	110	5	20x40x40	6.842	122,52



DİRSEK 45°  
45° ELBOW

Beyaz White	Kod Code		Çap Diameter (mm)	Paket Miktarı Box Quantity (pcs)	Paket Ebatı Box Dimension (cm)	Paket Ağırlığı Box Weight (kg)	Fiyat Price (TL)
	Yeşil Green	Gri Grey					
502-600502	700502	800502	20	500	20x40x40	6.855	1,18
502-600504	700504	800504	25	300	20x40x40	5.955	1,59
502-600506	700506	800506	32	200	20x40x40	7.055	2,56
502-600508	700508	800508	40	100	20x40x40	7.155	5,99
502-600510	700510	800510	50	50	20x40x40	4.930	9,66
502-600512	700512	800512	63	25	20x40x40	6.805	19,00
702-600514	700514	800514	75	16	20x40x40	6.848	39,74
702-600516	700516	800516	90	9	20x40x40	5.517	79,50
702-600518	700518	800518	110	5	20x40x40	5.480	133,10



TE PARÇA  
T PIECE

Beyaz White	Kod Code		Çap Diameter (mm)	Paket Miktarı Box Quantity (pcs)	Paket Ebatı Box Dimension (cm)	Paket Ağırlığı Box Weight (kg)	Fiyat Price (TL)
	Yeşil Green	Gri Grey					
502-600602	700602	800602	20	300	20x40x40	6.255	1,21
502-600604	700604	800604	25	200	20x40x40	6.455	1,59
502-600606	700606	800606	32	100	20x40x40	6.105	3,69
502-600608	700608	800608	40	50	20x40x40	6.155	5,54
502-600610	700610	800610	50	30	20x40x40	5.775	10,23
502-600612	700612	800612	63	20	20x40x40	7.675	26,91
702-600614	700614	800614	75	12	20x40x40	6.950	44,89
702-600616	700616	800616	90	8	20x40x40	8.380	67,90
702-600618	700618	800618	110	4	20x40x40	6.483	119,51



MANŞON  
COUPLING

Beyaz White	Kod Code		Çap Diameter (mm)	Paket Miktarı Box Quantity (pcs)	Paket Ebatı Box Dimension (cm)	Paket Ağırlığı Box Weight (kg)	Fiyat Price (TL)
	Yeşil Green	Gri Grey					
502-600702	700702	800702	20	750	20x40x40	7.905	0,67
502-600704	700704	800704	25	400	20x40x40	6.255	0,91
502-600706	700706	800706	32	250	20x40x40	6.480	1,78
502-600708	700708	800708	40	125	20x40x40	6.480	2,92
502-600710	700710	800710	50	75	20x40x40	6.930	5,39
502-600712	700712	800712	63	40	20x40x40	6.895	9,46
502-600714	700714	800714	75	32	20x40x40	7.456	18,78
702-600716	700716	800716	90	20	20x40x40	6.400	31,76
702-600718	700718	800718	110	12	20x40x40	8.420	45,55

REDÜKSİYON  
REDUCER



Beyaz White	Kod Code		Çap Diameter (mm)	Paket Miktarı Box Quantity (pcs)	Paket Ebatı Box Dimension (cm)	Paket Ağırlığı Box Weight (kg)	Fiyat Price (TL)
	Yeşil Green	Gri Grey					
502-600752	700752	800752	25-20	600	20x40x40	5.955	0,68
502-600754	700754	800754	32-20	400	20x40x40	7.055	1,10
502-600756	700756	800756	32-25	400	20x40x40	6.255	1,29
502-600758	700758	800758	40-25	200	20x40x40	5.843	2,55
502-600760	700760	800760	40-32	200	20x40x40	6.505	2,65
502-600762	700762	800762	50-32	100	20x40x40	8.055	4,35
502-600764	700764	800764	50-40	100	20x40x40	7.405	4,61
502-600766	700766	800766	63-40	60	20x40x40	8.235	8,89
502-600768	700768	800768	63-50	60	20x40x40	6.855	8,28
702-600770	700770	800770	40-20	350	20x40x40	9.550	2,52
702-600772	700772	800772	50-25	200	20x40x40	8.000	4,13
702-600774	700774	800774	63-32	80	20x40x40	7.208	12,14
702-600776	700776	800776	75-32	50	20x40x40	6.800	18,20
702-600778	700778	800778	75-40	50	20x40x40	6.550	20,36
702-600780	700780	800780	75-50	50	20x40x40	7.300	17,15
702-600782	700782	800782	75-63	40	20x40x40	8.600	20,06
702-600784	700784	800784	90-63	32	20x40x40	8.480	25,93
702-600786	700786	800786	90-75	32	20x40x40	9.792	26,47

İNEGAL TE  
İNEGAL T



Beyaz White	Kod Code		Çap Diameter (mm)	Paket Miktarı Box Quantity (pcs)	Paket Ebatı Box Dimension (cm)	Paket Ağırlığı Box Weight (kg)	Fiyat Price (TL)
	Yeşil Green	Gri Grey					
702-600800	700800	800800	25-20-20	200	20x40x40	7.505	1,86
702-600801	700801	800801	25-25-20	200	20x40x40	6.800	2,49
502-600802	700802	800802	25-20-25	250	20x40x40	6.855	2,16
502-600804	700804	800804	32-20-32	120	20x40x40	6.555	3,49
502-600806	700806	800806	32-25-32	120	20x40x40	5.955	3,60
502-600808	700808	800808	40-32-40	70	20x40x40	6.455	8,54
502-600810	700810	800810	40-25-40	70	20x40x40	6.035	7,36
702-600812	700812	800812	40-20-40	70	20x40x40	5.400	6,77
702-600814	700814	800814	50-20-50	25	20x40x40	7.100	16,68
702-600816	700816	800816	50-25-50	30	20x40x40	8.090	18,56
702-600818	700818	800818	50-32-50	30	20x40x40	6.425	18,78
702-600819	700819	800819	50-40-50	25	20x40x40	6.550	19,21
702-600820	700820	800820	63-20-63	20	20x40x40	8.640	36,21
702-600822	700822	800822	63-25-63	20	20x40x40	8.360	28,84
702-600824	700824	800824	63-32-63	20	20x40x40	8.160	30,29
702-600826	700826	800826	63-40-63	20	20x40x40	8.000	30,94
702-600828	700828	800828	63-50-63	20	20x40x40	7.700	31,56

KAPAMA BAŞLIĞI  
STOP END



Beyaz White	Kod Code		Çap Diameter (mm)	Paket Miktarı Box Quantity (pcs)	Paket Ebatı Box Dimension (cm)	Paket Ağırlığı Box Weight (kg)	Fiyat Price (TL)
	Yeşil Green	Gri Grey					
502-600902	700902	800902	20	750	20x40x40	6.480	0,68
502-600904	700904	800904	25	500	20x40x40	5.605	1,07
502-600906	700906	800906	32	400	20x40x40	8.055	1,78
502-600908	700908	800908	40	200	20x40x40	7.755	2,62
502-600910	700910	800910	50	100	20x40x40	8.005	5,02
502-600912	700912	800912	63	50	20x40x40	7.005	9,60



**KÖPRÜ (Kavisli)**  
BRIDGE (with Coupling)

Kod Code			Çap Diameter (mm)	Paket Miktarı Box Quantity (pcs)	Paket Ebatı Box Dimension (cm)	Paket Ağırlığı Box Weight (kg)	Fiyat Price (TL)
Beyaz White	Yeşil Green	Gri Grey					
502-610102	710102	810102	20	125	20x40x40	5.324	3,40
502-610104	710104	810104	25	90	20x40x40	6.030	5,07
502-610106	710106	810106	32	50	20x40x40	6.280	10,96



**KAVISLİ C**  
SHORT C BRIDGE WITH COUPLING

Kod Code			Çap Diameter (mm)	Paket Miktarı Box Quantity (pcs)	Paket Ebatı Box Dimension (cm)	Paket Ağırlığı Box Weight (kg)	Fiyat Price (TL)
Beyaz White	Yeşil Green	Gri Grey					
702-610152	710152	810152	20	200	20x40x40	6.055	3,00
702-610154	710154	810154	25	150	20x40x40	6.555	4,44



**ÇEKVALF**  
CHECK VALVE

Kod Code			Çap Diameter (mm)	Paket Miktarı Box Quantity (pcs)	Paket Ebatı Box Dimension (cm)	Paket Ağırlığı Box Weight (kg)	Fiyat Price (TL)
Beyaz White	Yeşil Green	Gri Grey					
702-620940	720940	820940	20	100	20x40x40	10.882	18,83
702-620942	720942	820942	25	100	20x40x40	11.048	20,85



**İÇ DİŞLİ NİPEL**  
FEMALE NIPPLE

Kod Code			Çap Diameter (mm)	Paket Miktarı Box Quantity (pcs)	Paket Ebatı Box Dimension (cm)	Paket Ağırlığı Box Weight (kg)	Fiyat Price (TL)
Beyaz White	Yeşil Green	Gri Grey					
502-610400	710400	810400	20 1/2 "	200	20x40x40	8.555	6,30
502-610401	710401	810401	20 3/4"	200	20x40x40	9.455	8,82
502-610402	710402	810402	25 3/4"	200	20x40x40	11.225	8,99
502-610403	710403	810403	25 1/2"	200	20x40x40	11.005	6,86
502-610404	710404	810404	32 1 "	100	20x40x40	8.305	21,13
502-610405	710405	810405	32 3/4"	100	20x40x40	7.15	20,15



**İÇ DİŞLİ NİPEL**  
FEMALE NIPPLE (Hexagon)

Kod Code			Çap Diameter (mm)	Paket Miktarı Box Quantity (pcs)	Paket Ebatı Box Dimension (cm)	Paket Ağırlığı Box Weight (kg)	Fiyat Price (TL)
Beyaz White	Yeşil Green	Gri Grey					
502-610406	710406	810406	40 1 1/4"	40	20x40x40	9.375	34,49
502-610407	710407	810407	50 1 1/2"	40	20x40x40	10.695	50,61
502-610408	710408	810408	63 2 "	20	20x40x40	11.685	81,82
702-610410	710410	810410	75 2 1/2"	12	20x40x40	11.470	171,78
702-610412	710412	810412	90x3"	12	20x40x40	12.970	247,42



DIŞ DIŞLİ NİPEL  
MALE NIPPLE

Beyaz White	Kod Code		Çap Diameter (mm)	Paket Miktarı Box Quantity (pcs)	Paket Ebatı Box Dimension (cm)	Paket Ağırlığı Box Weight (kg)	Fiyat Price (TL)
	Yeşil Green	Gri Grey					
502-610500	710500	810500	20 1/2 "	200	20x40x40	10.455	7,66
502-610501	710501	810501	20 3/4"	200	20x40x40	13.455	11,44
502-610502	710502	810502	25 3/4"	200	20x40x40	13.855	11,65
502-610503	710503	810503	25 1/2"	200	20x40x40	12.555	9,09
502-610504	710504	810504	32 1 "	100	20x40x40	10.230	21,53
502-610505	710505	810505	32 3/4"	100	20x40x40	8.655	21,40



DIŞ DIŞLİ NİPEL  
MALE NIPPLE (Hexagon)

Beyaz White	Kod Code		Çap Diameter (mm)	Paket Miktarı Box Quantity (pcs)	Paket Ebatı Box Dimension (cm)	Paket Ağırlığı Box Weight (kg)	Fiyat Price (TL)
	Yeşil Green	Gri Grey					
502-610506	710506	810506	40 1 1/4"	40	20x40x40	12.375	45,95
502-610507	710507	810507	50 1 1/2"	40	20x40x40	15.055	56,98
502-610508	710508	810508	63 2 "	20	20x40x40	10.675	97,79
702-610510	710510	810510	75 2 1/2"	12	20x40x40	10.122	192,47
702-610512	710512	810512	90 3"	12	20x40x40	13.540	273,35



OYNAR BAŞLI İÇ DIŞLİ REKOR  
TRANSITION UNION FEMALE

Beyaz White	Kod Code		Çap Diameter (mm)	Paket Miktarı Box Quantity (pcs)	Paket Ebatı Box Dimension (cm)	Paket Ağırlığı Box Weight (kg)	Fiyat Price (TL)
	Yeşil Green	Gri Grey					
502-610600	710600	810600	20 1/2 "	200	20x40x40	13.955	14,20
502-610602	710602	810602	25 3/4"	150	20x40x40	14.655	20,31
502-610604	710604	810604	32 1 "	100	20x40x40	12.925	27,21
502-610606	710606	810606	40 1 1/4"	50	20x40x40	12.430	49,95
502-610608	710608	810608	50 1 1/2"	25	20x40x40	8.849	77,27



OYNAR BAŞLI DIŞ DIŞLİ REKOR  
TRANSITION UNION MALE

Beyaz White	Kod Code		Çap Diameter (mm)	Paket Miktarı Box Quantity (pcs)	Paket Ebatı Box Dimension (cm)	Paket Ağırlığı Box Weight (kg)	Fiyat Price (TL)
	Yeşil Green	Gri Grey					
502-610700	710700	810700	20 1/2 "	200	20x40x40	14.955	15,03
502-610702	710702	810702	25 3/4"	150	20x40x40	16.305	24,10
502-610704	710704	810704	32 1 "	100	20x40x40	14.025	33,13
502-610706	710706	810706	40 1 1/4"	50	20x40x40	14.480	56,78
502-610708	710708	810708	50 1 1/2"	25	20x40x40	9.524	93,09





DIŞ DIŞLİ 90° DİRSEK  
90° MALE ELBOW

	Kod Code			Çap Diameter (mm)	Paket Miktarı Box Quantity (pcs)	Paket Ebatı Box Dimension (cm)	Paket Ağırlığı Box Weight (kg)	Fiyat Price (TL)
	Beyaz White	Yeşil Green	Gri Grey					
502-620100	720100	820100	20 1/2 "	200	20x40x40	13.405	8,78	
502-620101	720101	820101	20 3/4"	200	20x40x40	15.805	12,84	
502-620102	720102	820102	25 3/4"	150	20x40x40	11.918	13,15	
502-620103	720103	820103	25 1/2"	150	20x40x40	11.255	9,80	
502-620104	720104	820104	32 1 "	100	20x40x40	12.205	23,58	
502-620105	720105	820105	32 3/4"	100	20x40x40	10.575	15,74	



İÇ DIŞLİ 90° DİRSEK  
FEMALE ELBOW 90°

	Kod Code			Çap Diameter (mm)	Paket Miktarı Box Quantity (pcs)	Paket Ebatı Box Dimension (cm)	Paket Ağırlığı Box Weight (kg)	Fiyat Price (TL)
	Beyaz White	Yeşil Green	Gri Grey					
502-620150	720150	820150	20 1/2 "	200	20x40x40	11.455	6,59	
502-620151	720151	820151	20 3/4"	200	20x40x40	13.055	9,92	
502-620152	720152	820152	25 3/4"	150	20x40x40	10.080	10,84	
502-620153	720153	820153	25 1/2"	150	20x40x40	9.655	9,90	
502-620154	720154	820154	32 1 "	100	20x40x40	10.155	20,85	
502-620155	720155	820155	32 3/4"	100	20x40x40	9.355	14,77	



İÇ DIŞLİ TE  
FEMALE T

	Kod Code			Çap Diameter (mm)	Paket Miktarı Box Quantity (pcs)	Paket Ebatı Box Dimension (cm)	Paket Ağırlığı Box Weight (kg)	Fiyat Price (TL)
	Beyaz White	Yeşil Green	Gri Grey					
502-620300	720300	820300	20 1/2 "	200	20x40x40	10.655	7,04	
502-620301	720301	820301	20 3/4"	200	20x40x40	11.455	9,92	
502-620302	720302	820302	25 3/4"	160	20x40x40	10.775	10,44	
502-620303	720303	820303	25 1/2"	160	20x40x40	10.615	8,44	
502-620304	720304	820304	32 1 "	80	20x40x40	8.495	19,69	
502-620305	720305	820305	32 3/4"	80	20x40x40	8.327	14,20	



DIŞ DIŞLİ TE  
MALE T

	Kod Code			Çap Diameter (mm)	Paket Miktarı Box Quantity (pcs)	Paket Ebatı Box Dimension (cm)	Paket Ağırlığı Box Weight (kg)	Fiyat Price (TL)
	Beyaz White	Yeşil Green	Gri Grey					
502-620350	720350	820350	20 1/2 "	200	20x40x40	13.855	9,25	
502-620351	720351	820351	20 3/4"	200	20x40x40	14.855	13,93	
502-620352	720352	820352	25 3/4"	160	20x40x40	12.855	14,26	
502-620353	720353	820353	25 1/2"	160	20x40x40	12.215	10,66	
502-620354	720354	820354	32 1 "	80	20x40x40	10.935	24,38	
502-620355	720355	820355	32 3/4"	80	20x40x40	9.335	19,67	



BATARYA BAĞLANTISI  
TAP CONNECTION

	Kod Code			Çap Diameter (mm)	Paket Miktarı Box Quantity (pcs)	Paket Ebatı Box Dimension (cm)	Paket Ağırlığı Box Weight (kg)	Fiyat Price (TL)
	Beyaz White	Yeşil Green	Gri Grey					
502-620400	720400	820400	20 1/2 "	200	20x40x40	11.405	7,37	
502-620402	720402	820402	25 3/4"	100	20x40x40	7.355	11,34	
502-620404	720404	820404	25 1/2"	100	20x40x40	6.855	8,61	

KELEBEK BAŞLI VANA  
START BUTTERFLY VALVE

Beyaz White	Kod Code		Çap Diameter (mm)	Paket Miktarı Box Quantity (pcs)	Paket Ebatı Box Dimension (cm)	Paket Ağırlığı Box Weight (kg)	Fiyat Price (TL)
	Yeşil Green	Gri Grey					
502-620500	720500	820500	20 1/2"	50	20x40x40	7.905	28,73
502-620502	720502	820502	25 3/4"	50	20x40x40	9.643	29,92
702-620504	720504	820504	32 1"	40	20x40x40	11.440	42,77



KROM LÜKS VANA  
CHROME PLATED LONG VALVE

Beyaz White	Kod Code		Çap Diameter (mm)	Paket Miktarı Box Quantity (pcs)	Paket Ebatı Box Dimension (cm)	Paket Ağırlığı Box Weight (kg)	Fiyat Price (TL)
	Yeşil Green	Gri Grey					
502-620850	720850	820850	20	50	20x40x40	14.155	73,79
502-620852	720852	820852	25	50	20x40x40	15.093	78,53



KROM LÜKS GİZLİ VANA  
CHROME PLATED HIDDEN VALVE

Beyaz White	Kod Code		Çap Diameter (mm)	Paket Miktarı Box Quantity (pcs)	Paket Ebatı Box Dimension (cm)	Paket Ağırlığı Box Weight (kg)	Fiyat Price (TL)
	Yeşil Green	Gri Grey					
502-620840	720840	820840	20	50	20x40x40	10.655	59,12
502-620842	720842	820842	25	50	20x40x40	11.743	64,02



KÜRESEL VANA  
BALL VALVE

Beyaz White	Kod Code		Çap Diameter (mm)	Paket Miktarı Box Quantity (pcs)	Paket Ebatı Box Dimension (cm)	Paket Ağırlığı Box Weight (kg)	Fiyat Price (TL)
	Yeşil Green	Gri Grey					
702-620800	720800	820800	20	100	20x40x40	11.555	29,85
702-620802	720802	820802	25	75	20x40x40	11.730	38,04
702-620804	720804	820804	32	50	20x40x40	11.605	55,35
702-620806	720806	820806	40	20	20x40x40	10.755	75,60
702-620808	720808	820808	50	20	20x40x40	15.50	97,17
702-620810	720810	820810	63	15	20x40x40	12.50	173,05
702-620812	720812	820812	75	5	20x40x40	6.90	252,92





OYNAR BAŞLI NİPEL  
NIPPLE WITH LOOSE NUT

Kod Code			Çap Diameter (mm)	Paket Miktarı Box Quantity (pcs)	Paket Ebatı Box Dimension (cm)	Paket Ağırlığı Box Weight (kg)	Fiyat Price (TL)
Beyaz White	Yeşil Green	Gri Grey					
702-620860	720860	820860	20 1/2"	250	20x40x40	16.105	23,07
702-620862	720862	820862	25 3/4"	150	20x40x40	11.805	28,79



OYNAR BAŞLI DİRSEK  
ELBOW WITH LOOSE NUT

Kod Code			Çap Diameter (mm)	Paket Miktarı Box Quantity (pcs)	Paket Ebatı Box Dimension (cm)	Paket Ağırlığı Box Weight (kg)	Fiyat Price (TL)
Beyaz White	Yeşil Green	Gri Grey					
702-620900	720900	820900	20 1/2"	200	20x40x40	9.055	23,76
702-620902	720902	820902	25 3/4"	150	20x40x40	8.505	29,75



TEKLİ KELEPÇE  
SINGLE CLAMPS

Kod Code			Çap Diameter (mm)	Paket Miktarı Box Quantity (pcs)	Paket Ebatı Box Dimension (cm)	Paket Ağırlığı Box Weight (kg)	Fiyat Price (TL)
Beyaz White	Yeşil Green	Gri Grey					
502-620600	720600	820600	20	1250	20x40x40	5.480	0,64
502-620602	720602	820602	22	1250	20x40x40	5.855	0,67
502-620604	720604	820604	25	750	20x40x40	5.505	0,77
502-620606	720606	820606	27	750	20x40x40	5.655	0,84
502-620608	720608	820608	32	500	20x40x40	5.355	0,94
502-620610	720610	820610	34	500	20x40x40	5.605	1,01
502-620612	720612	820612	40	400	20x40x40	4.855	1,21
502-620614	720614	820614	50	300	20x40x40	5.505	2,62
502-620616	720616	820616	63	200	20x40x40	5.855	4,06



ÇİFTLİ KELEPÇE  
DOUBLE CLAMPS

Kod Code			Çap Diameter (mm)	Paket Miktarı Box Quantity (pcs)	Paket Ebatı Box Dimension (cm)	Paket Ağırlığı Box Weight (kg)	Fiyat Price (TL)
Beyaz White	Yeşil Green	Gri Grey					
502-620650	720650	820650	20	600	20x40x40	4.755	0,84
502-620652	720652	820652	25	500	20x40x40	5.605	1,18
502-620654	720654	820654	32	300	20x40x40	5.655	1,65

KÖR TAPA  
STOP END THREADED

Beyaz White	Kod Code		Çap Diameter (mm)	Paket Miktarı Box Quantity (pcs)	Paket Ebatı Box Dimension (cm)	Paket Ağırlığı Box Weight (kg)	Fiyat Price (TL)
	Yeşil Green	Gri Grey					
502-620550	720550	820550	20 1/2"	1000	20x40x40	6.355	0,64
502-620552	720552	820552	25 3/4"	750	20x40x40	5.355	0,77
502-620554	720554	820554	32 1"	400	20x40x40	6.255	1,00



SÜZGEÇ  
FILTER

Beyaz White	Kod Code		Çap Diameter (mm)	Paket Miktarı Box Quantity (pcs)	Paket Ebatı Box Dimension (cm)	Paket Ağırlığı Box Weight (kg)	Fiyat Price (TL)
	Yeşil Green	Gri Grey					
702-620930	720930	820930	20	150	20x40x40	13.455	19,20
702-620932	720932	820932	25	100	20x40x40	13.555	20,29



İKİLİ BATARYA BAĞLANTISI  
DOUBLE TAP CONNECTION

Beyaz White	Kod Code		Çap Diameter (mm)	Paket Miktarı Box Quantity (pcs)	Paket Ebatı Box Dimension (cm)	Paket Ağırlığı Box Weight (kg)	Fiyat Price (TL)
	Yeşil Green	Gri Grey					
702-620980	720980	820980	20 1/2"	50	20x40x40	7.405	27,79
702-620982	720982	820982	25 1/2"	50	20x40x40	7.555	32,02



AYARLANABİLİR BATARYA  
ADJUSTABLE TAP CONNECTION

Beyaz White	Kod Code		Çap Diameter (mm)	Paket Miktarı Box Quantity (pcs)	Paket Ebatı Box Dimension (cm)	Paket Ağırlığı Box Weight (kg)	Fiyat Price (TL)
	Yeşil Green	Gri Grey					
702-620990	720990	820990	20 1/2"	25	20x40x40	6.530	23,62
702-620992	720992	820992	25 1/2"	25	20x40x40	6.080	36,81

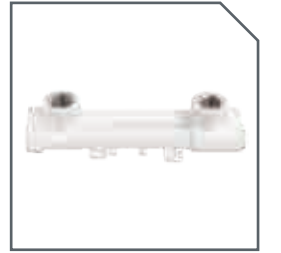

TAHARET BATARYASI  
BIDET TAP CONNECTION

Beyaz White	Kod Code		Çap Diameter (mm)	Paket Miktarı Box Quantity (pcs)	Paket Ebatı Box Dimension (cm)	Paket Ağırlığı Box Weight (kg)	Fiyat Price (TL)
	Yeşil Green	Gri Grey					
702-620994	720994	820994	20 1/2"	70	20x40x40	3.380	20,60

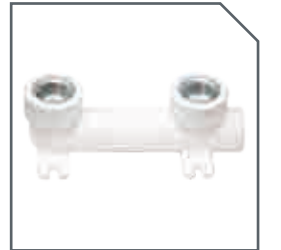





KAYNAK MAKİNASI (Yuvarlak)  
WELDING MACHINE (Round)

Kod Code	Çap Diameter (mm)	Paket Miktarı Box Quantity (pcs)	Paket Ebatı Box Dimension (cm)	Paket Ağırlığı Box Weight (kg)	Fiyat Price (TL)
702-620780	-	1	31x47x10	2.50	646,08



KAYNAK MAKİNASI  
WELDING MACHINE

Kod Code	Çap Diameter (mm)	Paket Miktarı Box Quantity (pcs)	Paket Ebatı Box Dimension (cm)	Paket Ağırlığı Box Weight (kg)	Fiyat Price (TL)
702-620782	20-40	1	31x47x10	5.72	598,07



BORU MAKASI  
PIPE SCISSORS

Kod Code	Çap Diameter (mm)	Paket Miktarı Box Quantity (pcs)	Paket Ebatı Box Dimension (cm)	Paket Ağırlığı Box Weight (kg)	Fiyat Price (TL)
702-720780	20-40	5	14x27x12	0.5	110,75



KAYNAK PAFTASI  
WELDING APPARATUS

Kod Code	Çap Diameter (mm)	Paket Miktarı Box Quantity (pcs)	Paket Ebatı Box Dimension (cm)	Paket Ağırlığı Box Weight (kg)	Fiyat Price (TL)
702-720750	20	1	-	0.093	28,20
702-720752	25	1	-	0.118	31,06
702-720754	32	1	-	0.188	41,29
702-720756	40	1	-	0.267	52,41
702-720758	50	1	-	0.396	118,95
702-720760	63	1	-	0.746	185,40
702-720762	75	1	-	1.365	247,64
702-720764	90	1	-	2.440	306,36
702-720766	110	1	-	2.700	357,06
702-720768	125	1	-	2.850	422,35

KOMBİ BAĞLANTI SETİ (Nipelli)

GAS BOILER INSTALLATION SET (Nipple)

Kod Code	Çap Diameter (mm)	Paket Miktarı Box Quantity (pcs)	Paket Ebatı Box Dimension (cm)	Paket Ağırlığı Box Weight (kg)	Fiyat Price (TL)
702-620700 (8 pcs)	20-25	18	18x12x12	0.800	143,41
702-620701 (10 pcs)	20-25	18	18x12x12	1.050	201,58



KOMBİ BAĞLANTI SETİ (Dirsekli)

GAS BOILER INSTALLATION SET (Elbow)

Kod Code	Çap Diameter (mm)	Paket Miktarı Box Quantity (pcs)	Paket Ebatı Box Dimension (cm)	Paket Ağırlığı Box Weight (kg)	Fiyat Price (TL)
702-620702 (8 pcs)	20-25	18	18x12x12	0.800	143,41
702-620703 (10 pcs)	20-25	18	18x12x12	1.100	201,58



# BORU PIPE

**BİNA İÇİ ISITMA SİSTEMLERİ  
PEX - AL - PEX - PERT BORULAR VE  
EK PARÇALARI**

INDOOR HEATING SYSTEMS  
PEX - AL-PEX - PERT PIPES and FITTINGS

PPR-C YERDEN ISITMA BORUSU  
PPR-C FLOOR HEATING PIPE

Kod Code	Çap Diameter (mm)	Paket Miktarı Box Quantity (m)	Paket Ebatı Box Dimension (cm)	Paket Ağırlığı Box Weight (kg)	Fiyat Price (TL)
502-00017280	17 x 2	80	70 x 25	7	4,58
502-000172100	17 x 2	100	73 x 25	10.5	4,58
502-000172160	17 x 2	160	76 x 25	14	4,58



PERT PLUS BORU  
PIPE

Kod Code	Çap Diameter (mm)	Paket Miktarı Box Quantity (m)	Paket Ebatı Box Dimension (cm)	Paket Ağırlığı Box Weight (kg)	Fiyat Price (TL)
502-2162100	16x2	100	70x22	14.6	4,55



PERT BORU  
PIPE

Kod Code	Çap Diameter (mm)	Paket Miktarı Box Quantity (m)	Paket Ebatı Box Dimension (cm)	Paket Ağırlığı Box Weight (kg)	Fiyat Price (TL)
502-1162100	16x2	100	70x22	14.6	4,30



PERT OKSİJEN BARIYERLİ BORU  
PERT OXYGEN BARRIER PIPE

Kod Code	Çap Diameter (mm)	Paket Miktarı Box Quantity (m)	Paket Ebatı Box Dimension (cm)	Paket Ağırlığı Box Weight (kg)	Fiyat Price (TL)
502-PRO 162160	16 x 2	160	60x60x26	13.79	5,54



PIPE IN PIPE (PERT OKSİJEN BARIYERLİ KILIFLI BORU)  
PERT OXYGEN BARRIER PIPE SPIRAL COATED PIPE

Kod Code	Çap Diameter (mm)	Paket Miktarı Box Quantity (m)	Paket Ebatı Box Dimension (cm)	Paket Ağırlığı Box Weight (kg)	Fiyat Price (TL)
502-PRK 162100	16 x 2	100	70x22	14.6	7,34
502-PRM 162100	16 x 2	100	70x22	14.6	7,34



PERT KILIFLI BORU  
SPIRAL PIPE

Kod Code	Çap Diameter (mm)	Paket Miktarı Box Quantity (m)	Paket Ebatı Box Dimension (cm)	Paket Ağırlığı Box Weight (kg)	Fiyat Price (TL)
502-KKT1162100	16x2	100	70x22	14.6	6,15
502-KMT1162100	16x2	100	70x22	14.6	6,15





PEX - AL-PEX BORU  
PEX - AL-PEX PIPE

Kod Code	Çap Diameter (mm)	Paket Miktarı Box Quantity (m)	Paket Ebatı Box Dimension (cm)	Paket Ağırlığı Box Weight (kg)	Fiyat Price (TL)
502-1001620	16x2.0	100/200	70x22	10.2 / 20.4	10,50
502-1002020	20x2.0	100	70x25	14.00	17,45
502-1002525	25x2.5	100	70x25	20.10	28,06
502-1002630	26x3.0	100	70x25	23.91	32,27
502-1003230	32x3.0	50	75x25	15.50	62,55



PEX-B BORU  
PEX-B PIPE

Kod Code	Çap Diameter (mm)	Paket Miktarı Box Quantity (m)	Paket Ebatı Box Dimension (cm)	Paket Ağırlığı Box Weight (kg)	Fiyat Price (TL)
502-X162100	16x2	100	51x51x26	8.12	4,70
502-X162160	16x2	160	58x58x26	12.87	4,70
502-X 1622100	16x2.2	100	51x51x26	8.79	5,24
502-X 1622160	16x2.2	160	58x58x26	13.95	5,24
502-X 182160	18x2	160	58x58x26	14.7	6,80
502-X 202160	20x2	160	70x70x26	16.51	12,19
502-X 2523	25x2.3	80	70x70x26	12.03	25,33
502-X 3229	25x2.9	50	70x70x26	12.14	27,18



PEX-B OKSİJEN BARIYERLİ BORU  
PEX-B OXYGEN BARRIER PIPE

Kod Code	Çap Diameter (mm)	Paket Miktarı Box Quantity (m)	Paket Ebatı Box Dimension (cm)	Paket Ağırlığı Box Weight (kg)	Fiyat Price (TL)
502-XO 162100	16 x 2	100	60x60x26	8.69	5,93
502-XO 162160	16 x 2	160	60x60x26	13.79	5,93



PIPE IN PIPE (PEX-B OKSİJEN BARIYERLİ KILIFLI BORU)  
PEX-B OXYGEN BARRIER PIPE SPIRAL COATED PIPE

Kod Code	Çap Diameter (mm)	Paket Miktarı Box Quantity (m)	Paket Ebatı Box Dimension (cm)	Paket Ağırlığı Box Weight (kg)	Fiyat Price (TL)
502-XOM 162100	16 x 2	100	70x22	14.6	8,01
502-XOK 162100	16 x 2	100	70x22	14.6	8,01



PEX - B KILIFLI BORU  
PEX-B SPIRAL (Pipe in Pipe)

Kod Code	Çap Diameter (mm)	Paket Miktarı Box Quantity (m)	Paket Ebatı Box Dimension (cm)	Paket Ağırlığı Box Weight (kg)	Fiyat Price (TL)
502-XM 162100	16 x 2	100	70x22	14.6	6,69
502-XK 162100	16 x 2	100	70x22	14.6	6,69



KILIF BORU  
SPIRAL PIPE

Kod Code	Çap Diameter (mm)	Paket Miktarı Box Quantity (m)	Paket Ebatı Box Dimension (cm)	Paket Ağırlığı Box Weight (kg)	Fiyat Price (TL)
702-K 162	25	100	56x20	5.60	1,91
702-M 162	25	100	56x20	5.60	1,91



KOLLEKTÖR  
COLLECTOR

Kod Code	Çap Diameter (mm)	Paket Miktarı Box Quantity (pcs)	Paket Ebatı Box Dimension (cm)	Paket Ağırlığı Box Weight (kg)	Fiyat Price (TL)
702-162400	2 x 16 x 2	2	-	1.004	103,92
702-162402	3 x 16 x 2	2	-	1.432	149,62
702-162403	4 x 16 x 2	2	-	1.888	195,39
702-162404	5 x 16 x 2	2	-	2.338	239,60
702-162405	6 x 16 x 2	2	-	2.788	283,51
702-162406	7 x 16 x 2	2	-	3.268	335,39
702-162408	8 x 16 x 2	2	-	3.708	379,42
702-162410	9 x 16 x 2	2	-	4.18	423,33
702-162412	10 x 16 x 2	2	-	4.592	467,13
702-162414	11 x 16 x 2	2	-	5.05	513,86
702-162416	12 x 16 x 2	2	-	5.51	560,53

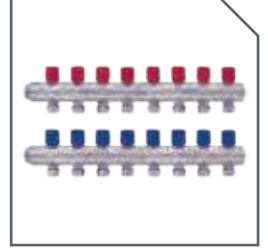
KOLLEKTÖR KELEPÇESİ  
COLLECTOR CLAMP

Kod Code	Çap Diameter (mm)	Paket Miktarı Box Quantity (pcs)	Paket Ebatı Box Dimension (cm)	Paket Ağırlığı Box Weight (kg)	Fiyat Price (TL)
702-001621	5	70	20x40x40	10	13,22

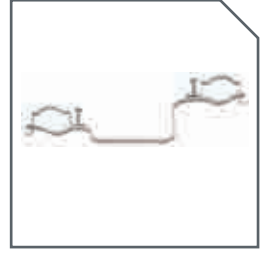
KOLLEKTÖR DOLABI  
COLLECTOR CABIN

Kod Code	Çap Diameter (mm)	Paket Miktarı Box Quantity (pcs)	Paket Ebatı Box Dimension (cm)	Paket Ağırlığı Box Weight (kg)	Fiyat Price (TL)
702-12630400	40x10x60	1	-	-	336,05
702-12630500	50x10x60	1	-	-	393,51
702-12630600	60x10x60	1	-	-	450,57
702-12630700	70x10x60	1	-	-	500,26
702-12630800	80x10x60	1	-	-	550,29
702-12630900	90x10x60	1	-	-	594,77
702-12631000	100x10x60	1	-	-	645,65

KOLLEKTÖR DOLABI LÜKS  
COLLECTOR CABIN LUXURY

Kod Code	Çap Diameter (mm)	Paket Miktarı Box Quantity (pcs)	Paket Ebatı Box Dimension (cm)	Paket Ağırlığı Box Weight (kg)	Fiyat Price (TL)
702-12630401	40x10x60	1	-	-	485,80
702-12630501	50x10x60	1	-	-	541,45
702-12630601	60x10x60	1	-	-	595,14
702-12630701	70x10x60	1	-	-	653,98
702-12630801	80x10x60	1	-	-	771,71
702-12630901	90x10x60	1	-	-	846,75
702-12631001	100x10x60	1	-	-	942,95





90° AL-PEX DİRSEK  
AL-PEX ELBOW 90°

Kod Code	Çap Diameter (mm)	Paket Miktarı Box Quantity (pcs)	Fiyat Price (TL)
702-0201160	16x16x2	200	32,23
702-0202200	20x20x2	150	34,19



AL-PEX TE  
AL-PEX T

Kod Code	Çap Diameter (mm)	Paket Miktarı Box Quantity (pcs)	Fiyat Price (TL)
702-0301160	16x16x16x2	120	41,10
702-0302200	20x20x20x2	84	43,51



AL-PEX İNEGAL TE  
AL-PEX INEGAL T

Kod Code	Çap Diameter (mm)	Paket Miktarı Box Quantity (pcs)	Fiyat Price (TL)
702-0402160	20x16x20x2	100	43,29
702-0401200	16x20x16x2	100	43,51



AL-PEX REDÜKSİYON TE  
AL-PEX REDUCER T

Kod Code	Çap Diameter (mm)	Paket Miktarı Box Quantity (pcs)	Fiyat Price (TL)
702-0501160	20x16x16x2	100	42,63
702-0502200	20x20x16x2	100	42,76



AL-PEX REDÜKSİYON  
AL-PEX REDUCER

Kod Code	Çap Diameter (mm)	Paket Miktarı Box Quantity (pcs)	Fiyat Price (TL)
702-0601160	20x16x2	200	31,03



AL-PEX MANŞON  
AL-PEX COUPLING

Kod Code	Çap Diameter (mm)	Paket Miktarı Box Quantity (pcs)	Fiyat Price (TL)
702-0701160	16x16x2	250	26,81
702-0702200	20x20x2	200	31,56

AL-PEX İÇ DİŞLİ NİPEL  
AL-PEX FEMALE NIPPLE

Kod Code	Çap Diameter (mm)	Paket Miktarı Box Quantity (pcs)	Fiyat Price (TL)
702-0801160	16x1/2x2	250	26,11
702-0802200	20x1/2x2	200	27,14
702-0803340	20x3 4x3	150	35,00



AL-PEX DİŞ DİŞLİ NİPEL  
AL-PEX MALE NIPPLE

Kod Code	Çap Diameter (mm)	Paket Miktarı Box Quantity (pcs)	Fiyat Price (TL)
702-0901160	16x1/2x2	300	24,92
702-0902200	20x1/2x2	200	24,82
702-0903340	20x3 4x3	200	30,47



AL-PEX İÇ DİŞ TE  
AL-PEX FEMALE T

Kod Code	Çap Diameter (mm)	Paket Miktarı Box Quantity (pcs)	Fiyat Price (TL)
702-0110116	16x1/2x16x2	100	40,54
702-0110220	20x1/2x20x2	100	40,77



AL-PEX DİŞ DİŞ TE  
AL-PEX MALE T

Kod Code	Çap Diameter (mm)	Paket Miktarı Box Quantity (pcs)	Fiyat Price (TL)
702-0120116	16x1/2x16x2	100	43,29
702-0120220	20x1/2x20x2	100	43,51



AL-PEX İÇ DİŞ DİRSEK  
AL-PEX FEMALE ELBOW

Kod Code	Çap Diameter (mm)	Paket Miktarı Box Quantity (pcs)	Fiyat Price (TL)
702-0130116	16x1/2x2	200	30,79
702-0130220	20x1/2x2	150	31,05



AL-PEX DİŞ DİŞ DİRSEK  
MALE ELBOW

Kod Code	Çap Diameter (mm)	Paket Miktarı Box Quantity (pcs)	Fiyat Price (TL)
702-0140116	16x1/2x2	200	34,35
702-0140220	20x1/2x2	150	34,54



AL-PEX KÖRTAPA  
AL-PEX STOP END

Kod Code	Çap Diameter (mm)	Paket Miktarı Box Quantity (pcs)	Fiyat Price (TL)
702-0150116	16x2	250	21,26
702-0150220	20x2	200	24,26





**KÖŞE RADYATÖR VANASI**  
CORNER RADIATOR VALVE

Kod Code	Çap Diameter (mm)	Paket Miktarı Box Quantity (pcs)	Paket Ebatı Box Dimension (cm)	Paket Ağırlığı Box Weight (kg)	Fiyat Price (TL)
702-162320	1/2"	70	35x20x20	11.00	39,02



**DÜZ RADYATÖR VANASI**  
STRAIGHT RADIATOR VALVE

Kod Code	Çap Diameter (mm)	Paket Miktarı Box Quantity (pcs)	Paket Ebatı Box Dimension (cm)	Paket Ağırlığı Box Weight (kg)	Fiyat Price (TL)
702-162323	1/2"	70	35x20x20	13.50	45,59



**PEX KÖŞE RADYATÖR VANASI**  
PEX CORNER RADIATOR VALVE

Kod Code	Çap Diameter (mm)	Paket Miktarı Box Quantity (pcs)	Paket Ebatı Box Dimension (cm)	Paket Ağırlığı Box Weight (kg)	Fiyat Price (TL)
702-162321	1/2" 16x2	70	35x20x20	12.50	44,94



**PEX DÜZ RADYATÖR VANASI**  
PEX STRAIGHT RADIATOR VALVE

Kod Code	Çap Diameter (mm)	Paket Miktarı Box Quantity (pcs)	Paket Ebatı Box Dimension (cm)	Paket Ağırlığı Box Weight (kg)	Fiyat Price (TL)
702-162325	1/2" 16x2	70	35x20x20	14.50	52,29

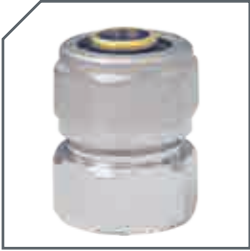

**MİNİ REKOR**  
MINI COMPRESSION COUPLING

Kod Code	Çap Diameter (mm)	Paket Miktarı Box Quantity (pcs)	Paket Ebatı Box Dimension (cm)	Paket Ağırlığı Box Weight (kg)	Fiyat Price (TL)
702-162202	16	250	35x20x20	16.25	15,03



**UZATMA ÇUBUĞU BAĞLANTI REKORU**  
EXTENDED PIPE CONNECTION COMPRESSION COUPLING

Kod Code	Çap Diameter (mm)	Paket Miktarı Box Quantity (pcs)	Paket Ebatı Box Dimension (cm)	Paket Ağırlığı Box Weight (kg)	Fiyat Price (TL)
702-162302	16	250	35x20x20	24.50	20,36



**REKORLU NİPEL**  
COUPLING WITH NIPPLE

Kod Code	Çap Diameter (mm)	Paket Miktarı Box Quantity (pcs)	Paket Ebatı Box Dimension (cm)	Paket Ağırlığı Box Weight (kg)	Fiyat Price (TL)
702-162304 Çıkış - Outlet	1/2"	250	35x20x20	15.20	14,67
702-162306 Giriş - Inlet	16x2	250	35x20x20	17.21	14,91

KÖŞE RADYATÖR MANŞON  
CORNER RADIATOR COUPLING

Kod Code	Çap Diameter (mm)	Paket Miktarı Box Quantity (pcs)	Paket Ebatı Box Dimension (cm)	Paket Ağırlığı Box Weight (kg)	Fiyat Price (TL)
702-162322	1/2"	50	35x20x20	13.70	30,35



ALTTAN GİRİŞ - ÇIKIŞ VANASI  
INLET - OUTLET VALVE

Kod Code	Çap Diameter (mm)	Paket Miktarı Box Quantity (pcs)	Paket Ebatı Box Dimension (cm)	Paket Ağırlığı Box Weight (kg)	Fiyat Price (TL)
702-162324	1/2"	25	35x20x20	6.85	42,59



KROM KAPLI PİRİNÇ UZATMA BORUSU  
CHROME PLATED BRASS EXTENSION PIPE

Kod Code	Çap Diameter (mm)	Paket Miktarı Box Quantity (pcs)	Paket Ebatı Box Dimension (cm)	Paket Ağırlığı Box Weight (kg)	Fiyat Price (TL)
702-162310	15	100	-	5.75	13,46
702-162311	45	50	-	5.00	33,04
702-162312	60	50	-	11.47	48,27
702-162313	90	50	-	17.24	71,73

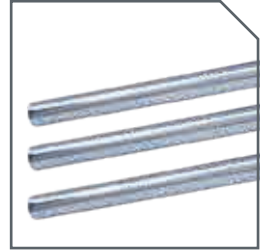

KÖŞE DÜZELTİCİ  
CORNER CORRECTIVE

Kod Code	Çap Diameter (mm)	Paket Miktarı Box Quantity (pcs)	Paket Ebatı Box Dimension (cm)	Paket Ağırlığı Box Weight (kg)	Fiyat Price (TL)
702-001616	16	150	60x40x40	14.50	2,25



KLİPSLİ LAMA  
CUTTING EDGE WITH CLIP

Kod Code	Çap Diameter (mm)	Paket Miktarı Box Quantity (pcs)	Paket Ebatı Box Dimension (cm)	Paket Ağırlığı Box Weight (kg)	Fiyat Price (TL)
702-001617	16	400	60x40x40	12.50	2,42

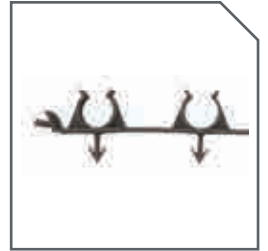

BORU TUTUCU  
PIPE HOLDER

Kod Code	Çap Diameter (mm)	Paket Miktarı Box Quantity (pcs)	Paket Ebatı Box Dimension (cm)	Paket Ağırlığı Box Weight (kg)	Fiyat Price (TL)
702-001620	25	10.000	Sack Çuval	15.50	0,27



YERE TESPİT DUBELİ  
WALL PLUG FOR FLOOR

Kod Code	Çap Diameter (mm)	Paket Miktarı Box Quantity (pcs)	Paket Ebatı Box Dimension (cm)	Paket Ağırlığı Box Weight (kg)	Fiyat Price (TL)
702-001618	16	7.500	Sack Çuval	13.75	0,20
702-001619	25	5.000	Sack Çuval	18.30	0,28



# BORU PIPE



**ATIK SU BORULARI ve EK PARÇALARI**  
PVC WASTE WATER PIPES and FITTINGS



PVC ATIK SU BORUSU TİP 1 (3.2 mm)  
PVC WASTE WATER PIPE TYPE 1 (3.2 mm)

Kod Code	Çap / Boy Diameter / Length (mm)	Paket Miktarı Bundle / Sack Quantity (pcs)	Ambalaj Tipi Packing Type	Fiyat Price (TL)
503-032000	50/150	150	Çuval Sack	4,24
503-032002	50/250	100	Çuval Sack	6,10
503-032004	50/500	50	Çuval Sack	8,64
503-032006	50/1000	5	Bağ Bundle	15,01
503-032008	50/2000	5	Bağ Bundle	29,41
503-032010	50/3000	5	Bağ Bundle	42,46
503-032012	50/6000	5	Bağ Bundle	82,60
503-032014	75/150	70	Çuval Sack	7,10
503-032016	75/250	50	Çuval Sack	10,91
503-032018	75/500	25	Çuval Sack	14,00
503-032020	75/1000	5	Bağ Bundle	25,80
503-032022	75/2000	5	Bağ Bundle	49,32
503-032024	75/3000	5	Bağ Bundle	70,11
503-032026	75/6000	5	Bağ Bundle	143,59
503-032028	110/150	35	Çuval Sack	11,92
503-032030	110/250	25	Çuval Sack	16,21
503-032032	110/500	12	Çuval Sack	22,30
503-032034	110/1000	3	Bağ Bundle	38,89
503-032036	110/2000	3	Bağ Bundle	73,84
503-032038	110/3000	3	Bağ Bundle	105,78
503-032040	110/6000	3	Bağ Bundle	215,93
503-032042	125/150	25	Çuval Sack	15,21
503-032044	125/250	15	Çuval Sack	21,22
503-032046	125/500	10	Çuval Sack	31,49
503-032048	125/1000	3	Bağ Bundle	54,76
503-032050	125/2000	3	Bağ Bundle	102,27
503-032052	125/3000	3	Bağ Bundle	151,33
503-032054	125/6000	3	Bağ Bundle	318,33
503-032056	160/150	15	Çuval Sack	22,51
503-032058	160/250	9	Çuval Sack	30,65
503-032060	160/500	5	Çuval Sack	48,10
503-032062	160/1000	3	Bağ Bundle	81,66
503-032064	160/2000	3	Bağ Bundle	154,35
503-032066	160/3000	3	Bağ Bundle	227,90
503-032068	160/6000	1	Bağ Bundle	449,94
503-032070	200/150	10	Bağ Bundle	37,78
503-032072	200/250	8	Bağ Bundle	48,62
503-032074	200/500	2	Bağ Bundle	83,16
503-032076	200/1000	1	Bağ Bundle	132,80
503-032078	200/2000	1	Bağ Bundle	250,18
503-032080	200/3000	1	Bağ Bundle	369,26
503-032082	200/6000	1	Bağ Bundle	728,64

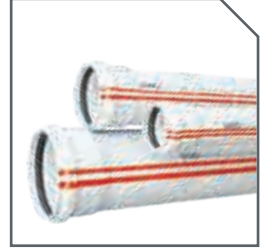

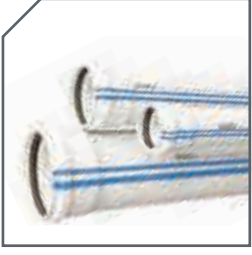

PVC ATIK SU BORUSU TİP 2 (2.2 mm)  
PVC WASTE WATER PIPE TYPE 2 (2.2 mm)

Kod Code	Çap / Boy Diameter / Length (mm)	Paket Miktarı Bundle / Sack Quantity (pcs)	Ambalaj Tipi Packing Type	Fiyat Price (TL)
503-022000	50/150	150	Çuval Sack	2,92
503-022002	50/250	100	Çuval Sack	3,90
503-022004	50/500	50	Çuval Sack	5,98
503-022006	50/1000	5	Bağ Bundle	10,69
503-022008	50/2000	5	Bağ Bundle	19,82
503-022010	50/3000	5	Bağ Bundle	29,75
503-022012	50/6000	5	Bağ Bundle	59,35
503-022014	75/150	70	Çuval Sack	6,00
503-022016	75/250	50	Çuval Sack	6,92
503-022018	75/500	25	Çuval Sack	9,51
503-022020	75/1000	5	Bağ Bundle	16,52
503-022022	75/2000	5	Bağ Bundle	32,26
503-022024	75/3000	5	Bağ Bundle	46,57
503-022026	75/6000	5	Bağ Bundle	94,01
503-022028	110/150	35	Çuval Sack	8,48
503-022030	110/250	25	Çuval Sack	11,53
503-022032	110/500	12	Çuval Sack	15,21
503-022034	110/1000	3	Bağ Bundle	26,57
503-022036	110/2000	3	Bağ Bundle	51,62
503-022038	110/3000	3	Bağ Bundle	72,74
503-022040	110/6000	3	Bağ Bundle	149,60
503-022042	125/150	25	Çuval Sack	9,33
503-022044	125/250	15	Çuval Sack	12,85
503-022046	125/500	10	Çuval Sack	22,94
503-022048	125/1000	3	Bağ Bundle	40,24
503-022050	125/2000	3	Bağ Bundle	76,83
503-022052	125/3000	3	Bağ Bundle	113,37
503-022054	125/6000	3	Bağ Bundle	220,29
503-022056	160/150	15	Çuval Sack	16,21
503-022058	160/250	9	Çuval Sack	25,36
503-022060	160/500	5	Çuval Sack	36,31
503-022062	160/1000	3	Bağ Bundle	63,59
503-022064	160/2000	3	Bağ Bundle	124,71
503-022066	160/3000	3	Bağ Bundle	198,80
503-022068	160/6000	1	Bağ Bundle	319,82
503-022070	200/150	10	Bağ Bundle	25,31
503-022072	200/250	8	Bağ Bundle	30,95
503-022074	200/500	2	Bağ Bundle	67,65
503-022076	200/1000	1	Bağ Bundle	114,36
503-022078	200/2000	1	Bağ Bundle	224,16
503-022080	200/3000	1	Bağ Bundle	286,43
503-022082	200/6000	1	Bağ Bundle	564,55

DİRSEK 45°  
45° ELBOW



Kod Code	Çap Diameter (mm)	Çuval Miktarı Sack Quantity (pcs)	Fiyat Price (TL)
503-032200	50x45	200	2,89
503-032202	75x45	125	5,25
503-032204	110x45	40	9,60
503-032206	125x45	25	14,87
503-032208	160x45	15	32,56
503-032210	200x45	8	110,17

DİRSEK 87°  
87° ELBOW



Kod Code	Çap Diameter (mm)	Çuval Miktarı Sack Quantity (pcs)	Fiyat Price (TL)
503-032224	50x87	200	4,06
503-032226	75x87	100	7,10
503-032228	110x87	30	12,81
503-032230	125x87	20	18,83
503-032232	160x87	10	43,39
503-032234	200x87	4	140,40

TEK ÇATAL 45°  
45° SINGLE BRANCH



Kod Code	Çap Diameter (mm)	Çuval Miktarı Sack Quantity (pcs)	Fiyat Price (TL)
503-032250	50x50x45	100	6,25
503-032252	75x50x45	50	8,68
503-032254	75x75x45	30	12,85
503-032256	110x50x45	30	14,14
503-032258	110x75x45	25	20,29
503-032260	110x110x45	15	25,00
503-032262	125x110x45	10	42,05
503-032264	125x125x45	10	51,18
503-032266	160x110x45	5	63,24
503-032268	160x125x45	8	71,93
503-032270	160x160x45	5	99,19
503-032272	200x110x45	5	126,32
702-032274	200x125x45	5	184,76
503-032276	200x160x45	4	200,40
503-032278	200x200x45	4	227,42



TE ÇATAL 87°  
87° T BRANCH

Kod Code	Çap Diameter (mm)	Çuval Miktarı Sack Quantity (pcs)	Fiyat Price (TL)
503-032300	50x50x87	100	6,19
503-032302	75x50x87	50	9,33
503-032304	75x75x87	50	11,64
503-032306	110x50x87	30	13,83
503-032308	110x75x87	25	20,45
503-032310	110x110x87	20	21,89
503-032312	125x110x87	10	38,26
503-032314	125x125x87	10	44,45
503-032316	160x110x87	5	62,91
702-032318	160x125x87	5	70,35
503-032320	160x160x87	5	90,90
702-032322	200x110x87	5	141,54
702-032324	200x160x87	5	184,76
702-032326	200x200x87	4	248,72



ÇİFT ÇATAL 45°  
45° DOUBLE BRANCH

Kod Code	Çap Diameter (mm)	Çuval Miktarı Sack Quantity (pcs)	Fiyat Price (TL)
503-032350	50x50x45	75	11,07
503-032352	75x50x45	50	15,45
503-032354	75x75x45	25	26,30
503-032356	110x50x45	10	25,39
503-032358	110x110x45	10	41,00



ISTAVROZ TE ÇATAL 87°  
87° CROSS T

Kod Code	Çap Diameter (mm)	Çuval Miktarı Sack Quantity (pcs)	Fiyat Price (TL)
503-032370	110x50x87	10	25,44
503-032372	110x110x87	10	53,35



REDÜKSİYON  
REDUCING SOCKET

Kod Code	Çap Diameter (mm)	Çuval Miktarı Sack Quantity (pcs)	Fiyat Price (TL)
503-032400	75x50	150	5,12
503-032402	110x50	75	8,48
503-032404	110x75	75	8,94
503-032406	125x110	40	16,21
503-032407	160x125	25	34,52
503-032408	160x110	10	28,91
503-032409	200x125	15	95,27
503-032410	200x110	15	90,12
503-032412	200x160	10	105,19

KAYAR MANŞON  
SLIDING COUPLING

Kod Code	Çap Diameter (mm)	Çuval Miktarı Sack Quantity (pcs)	Fiyat Price (TL)
503-032420	50	100	4,35
503-032422	75	50	6,76
503-032424	110	40	12,51
503-032426	125	30	25,47
503-032428	160	20	39,20
503-032429	200	8	76,27



ES SİFON  
S SIPHON

Kod Code	Çap Diameter (mm)	Çuval Miktarı Sack Quantity (pcs)	Fiyat Price (TL)
503-032430	75x75x45	30	25,78
503-032432	75x75x87	30	28,25
503-032434	110x110x45	10	33,60
503-032436	110x110x87	10	39,46



TEMİZLEME TE  
CLEANING T

Kod Code	Çap Diameter (mm)	Çuval Miktarı Sack Quantity (pcs)	Fiyat Price (TL)
702-032440	50	100	14,40
503-032441	75	50	20,80
503-032442	110	20	27,18
702-032443	125	10	53,69
503-032444	160	9	84,98
702-032446	200	4	209,67



MUF TAPASI  
PLUG

Kod Code	Çap Diameter (mm)	Çuval Miktarı Sack Quantity (pcs)	Fiyat Price (TL)
503-022480	50	500	2,55
503-022482	75	200	4,55
503-022484	110	125	6,30
702-022486	125	100	17,73
702-022488	160	100	21,32
702-022490	200	35	54,31



PNÖMATİK BORU  
PNEUMATIC PIPE

Kod Code	Çap / Boy Diameter / Length (mm)	Et Kalınlığı Thickness (mm)
503-022038-1	110	-
503-022066-2	160	-





SOMONLU KELEPÇE  
CLAMP WITH NUT

Kod Code	Çap Diameter (mm)	Çuval Miktarı Sack Quantity (pcs)	Fiyat Price (TL)
702-032461	50	125	7,76
702-032463	75	60	14,14
702-032465	110	50	19,17
702-032467	125	50	22,60
702-032469	160	30	27,71



TRİFONLU KELEPÇE  
CLAMP

Kod Code	Çap Diameter (mm)	Çuval Miktarı Sack Quantity (pcs)	Fiyat Price (TL)
702-032460	50	125	8,10
702-032462	75	60	14,59
702-032464	110	30	19,62
702-032466	125	25	22,77
702-032468	160	25	28,16



CONTA  
GASKET

Kod Code	Çap Diameter (mm)	Çuval Miktarı Sack Quantity (pcs)	Fiyat Price (TL)
702-032480	50	-	1,17
702-032482	75	-	1,79
702-032484	110	-	2,76
702-032486	125	-	4,72
702-032488	160	-	6,96
702-032490	200	-	17,39

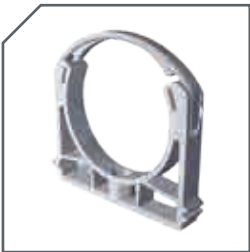

KAPAKLI KELEPÇE  
CLAMP WITH COVER

Kod Code	Çap Diameter (mm)	Çuval Miktarı Sack Quantity (pcs)	Fiyat Price (TL)
702-022460	50	150	1,95
702-022462	75	150	3,63
702-022464	110	100	5,51
702-022466	125	100	9,58
702-022468	160	50	16,36
702-022470	200	35	31,96



ÇATI OLUĞU  
RAIN DRAIN PIPE

Kod Code	Çap / Boy Diameter / Length (mm)	Paket Miktarı Bundle Quantity (pcs)	Fiyat Price (TL)
702-015040	150x4000	5	100,93

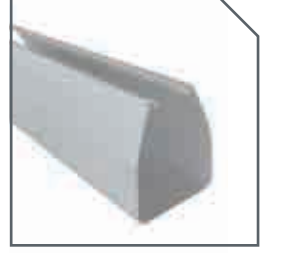

OLUK DİRSEĞİ 90°  
RAIN DRAIN PIPE WITH CORNER 90°

Kod Code	Çap / Boy Diameter / Length (mm)	Paket Miktarı Bundle Quantity (pcs)	Fiyat Price (TL)
702-015041	150	24	24,03

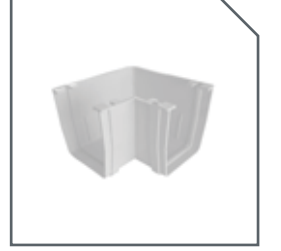

OLUK MANŞONU  
RAIN DRAIN PIPE SOCKET

Kod Code	Çap / Boy Diameter / Length (mm)	Paket Miktarı Bundle Quantity (pcs)	Fiyat Price (TL)
702-015042	150	40	22,67



OLUK İNiŞ  
RAIN DRAIN PIPE OUTLET

Kod Code	Çap / Boy Diameter / Length (mm)	Paket Miktarı Bundle Quantity (pcs)	Fiyat Price (TL)
702-015043	150x75	24	26,58
702-015045	150x110	24	47,85



OLUK KÖR TAPASI  
RAIN DRAIN PIPE STOP END

Kod Code	Çap / Boy Diameter / Length (mm)	Paket Miktarı Bundle Quantity (pcs)	Fiyat Price (TL)
702-015044	150	150	5,73



OLUK KELEPÇESİ  
DRAINAGE CLAMP

Kod Code	Çap / Boy Diameter / Length (mm)	Paket Miktarı Bundle Quantity (pcs)	Fiyat Price (TL)
702-015046	150	75	7,74



# PP ATIKSU BORUSU



PP ATIK SU BORUSU TİP 2 (2.2 mm)  
PP WASTE WATER PIPE TYPE 2 (2.2 mm)

Kod Code	Çap / Boy Diameter / Length (mm)	Paket Miktarı Bundle / Sack Quantity (pcs)	Ambalaj Tipi Packing Type	Fiyat Price (TL)
503-042000	50/150	150	Çuval Sack	4,57
503-042002	50/250	100	Çuval Sack	5,85
503-042004	50/500	50	Çuval Sack	8,95
503-042006	50/1000	10	Bağ Bundle	15,04
503-042008	50/2000	10	Bağ Bundle	28,49
503-042010	50/3000	10	Bağ Bundle	41,64
503-042012	50/6000	5	Bağ Bundle	81,86
503-042014	75/150	70	Çuval Sack	7,34
503-042016	75/250	50	Çuval Sack	9,55
503-042018	75/500	25	Çuval Sack	14,36
503-042020	75/1000	10	Bağ Bundle	25,30
503-042022	75/2000	10	Bağ Bundle	47,54
503-042024	75/3000	10	Bağ Bundle	70,10
503-042026	75/6000	5	Bağ Bundle	138,81
503-042028	110/150	35	Çuval Sack	11,61
503-042030	110/250	25	Çuval Sack	15,58
503-042032	110/500	12	Çuval Sack	24,29
503-042034	110/1000	6	Bağ Bundle	43,63
503-042036	110/2000	6	Bağ Bundle	83,73
503-042038	110/3000	6	Bağ Bundle	118,67
503-042040	110/6000	3	Bağ Bundle	243,81
503-042042	125/150	25	Çuval Sack	16,68
503-042044	125/250	15	Çuval Sack	22,24
503-042046	125/500	10	Çuval Sack	35,53
503-042048	125/1000	3	Bağ Bundle	62,78
503-042050	125/2000	3	Bağ Bundle	115,73
503-042052	125/3000	3	Bağ Bundle	170,13
503-042054	125/6000	3	Bağ Bundle	326,41
503-042056	160/150	15	Çuval Sack	26,25
503-042058	160/250	9	Çuval Sack	36,70
503-042060	160/500	5	Çuval Sack	53,52
503-042062	160/1000	3	Bağ Bundle	94,26
503-042064	160/2000	3	Bağ Bundle	175,10
503-042066	160/3000	3	Bağ Bundle	249,86
503-042068	160/6000	3	Bağ Bundle	486,00

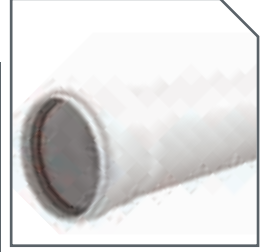



**DİRSEK 45°**  
45° ELBOW

Kod Code	Çap Diameter (mm)	Çuval Miktarı Sack Quantity (pcs)	Fiyat Price (TL)
503-022200	50x45	100	3,44
503-022202	75x45	40	6,28
503-022204	110x45	15	11,53
503-022206	125x45	10	17,53
503-022208	160x45	5	30,86



**DİRSEK 87°**  
87° ELBOW

Kod Code	Çap Diameter (mm)	Çuval Miktarı Sack Quantity (pcs)	Fiyat Price (TL)
503-022224	50x87	100	4,85
503-022226	75x87	40	8,54
503-022228	110x87	15	14,27
503-022230	125x87	10	21,17
503-022232	160x87	5	43,51



**TEK ÇATAL 45°**  
45° SINGLE BRANCH

Kod Code	Çap Diameter (mm)	Çuval Miktarı Sack Quantity (pcs)	Fiyat Price (TL)
503-022250	50x50x45	50	7,11
503-022252	75x50x45	25	10,16
503-022254	75x75x45	15	14,30
503-022256	110x50x45	10	16,04
503-022258	110x75x45	10	23,44
503-022260	110x110x45	6	26,65



**TE ÇATAL 87°**  
87° T BRANCH

Kod Code	Çap Diameter (mm)	Çuval Miktarı Sack Quantity (pcs)	Fiyat Price (TL)
503-022300	50x50x87	50	7,43
503-022302	75x50x87	30	10,79
503-022304	75x75x87	20	13,96
503-022306	110x50x87	15	16,14
503-022308	110x75x87	10	24,32
503-022310	110x110x87	8	25,20

ÇİFT ÇATAL 45°  
45° DOUBLE BRANCH

Kod Code	Çap Diameter (mm)	Çuval Miktarı Sack Quantity (pcs)	Fiyat Price (TL)
503-022350	50x50x45	30	12,61
503-022352	75x50x45	20	16,93
503-022354	75x75x45	10	29,71
503-022356	110x50x45	10	30,45
503-022358	110x110x45	5	42,65

İSTAVROZ TE ÇATAL 87°  
87° CROSS T

Kod Code	Çap Diameter (mm)	Çuval Miktarı Sack Quantity (pcs)	Fiyat Price (TL)
503-022370	110x50x87	10	27,73
503-022372	110x110x87	6	63,98

REDÜKSİYON  
REDUCING SOCKET

Kod Code	Çap Diameter (mm)	Çuval Miktarı Sack Quantity (pcs)	Fiyat Price (TL)
503-022400	75x50	75	5,81
503-022402	110x50	30	9,33
503-022404	110x75	25	10,70
503-022406	125x110	20	18,13
503-022408	160x110	10	32,56
503-022407	160x125	10	41,35

KAYAR MANŞON  
SLIDING COUPLING

Kod Code	Çap Diameter (mm)	Çuval Miktarı Sack Quantity (pcs)	Fiyat Price (TL)
503-022420	50	100	4,80
503-022422	75	50	8,01
503-022424	110	20	14,07





ES SIFON  
S SIPHON

Kod Code	Çap Diameter (mm)	Çuval Miktarı Sack Quantity (pcs)	Fiyat Price (TL)
503-022434	110x110x45	5	40,33
503-022436	110x110x87	5	43,27



TEMİZLEME TE  
CLEANING T

Kod Code	Çap Diameter (mm)	Çuval Miktarı Sack Quantity (pcs)	Fiyat Price (TL)
503-022442	110	10	24,96



MUF TAPASI  
PLUG

Kod Code	Çap Diameter (mm)	Çuval Miktarı Sack Quantity (pcs)	Fiyat Price (TL)
503-022480	50	500	2,55
503-022482	75	200	4,55
503-022484	110	125	6,30



# silenzio

**SESSİZ ÜÇ KATLI BORU**  
SILENT THREE LAYERED  
WASTE WATER PIPES

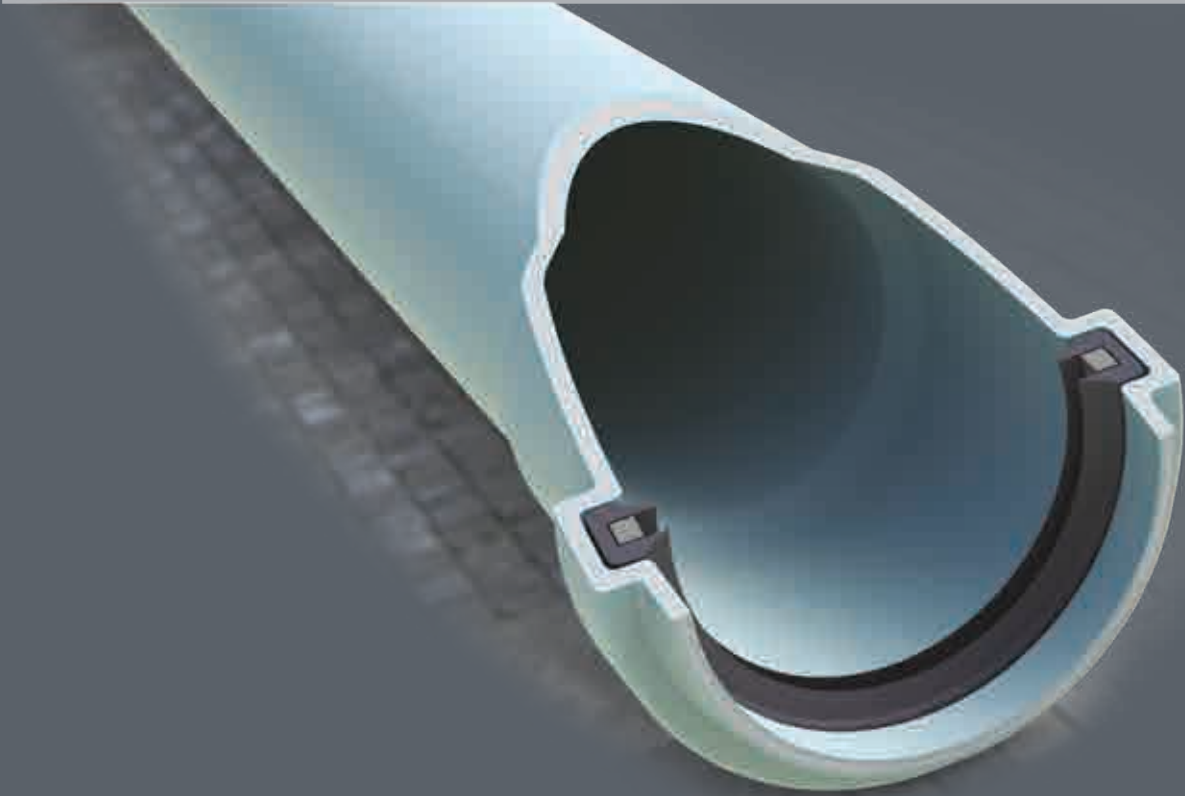

### SES GEÇİRMEYEN ATIKSU BORU SİSTEMİ SILENZIO

Silenzio Mineral takviyeli polipropilenden yapılmış yüksek kaliteli ses geçirmeyen boru sistemidir. Silenzio ürünleri bina yapımının her alanında (ev, konut, endüstriyel bina, hastaneler ve otel vb.) Geleceğe yönelik kullanımlar için ideal koşullar yaratarak mükemmel bir ses yalıtımı olanağı sağlar.

Ses yalıtımlı boru sistemleri yaşam kalitesiyle birlikte mülk değerinin artmasında katkıda bulunur. Günümüzde işkan alanlarındaki yüksek talepler göz önünde bulundurulduğunda silenzio boru sistemleri teknolojik ve ekonomik beklentileri tam anlamıyla karşılamaktadır.

Silenzio yüksek moleküler ağırlıktaki özel formülü ve 3 katlı yapısıyla atığın boru iç yüzeyine çarpmasıyla oluşan sesin tesisatın dışına çıkmasını engeller.

Aynı zamanda özel yapısı, tesisat üzerindeki titreşimleri büyük oranda azaltmaktadır. Böylece bina içerisinde titreşimler sonucu meydana gelen temas sesleri ve uğultular engellenmiş olur.

### SILENZIO - PROVIDES QUIET ENVIRONMENT

Silenzio - Sound Proof Waste Water Pipe System  
Silenzio is made by mineral reinforced polypropylene high quality sound proof pipe system. Silenzio products provide excellent sound isolation and create ideal living conditions for any type of buildings, houses, hospitals, hotels and etc. Sound isolated pipe systems make contribution of increasing life quality and property's value. Nowadays, taking into consideration of high housing demands, Silenzio pipe systems meet technological and economical expectations fully. Silenzio is with special formula that contains high level molecular weight and 3 layers structure, blocks the sound out of the waste water's impact to the inner surface. At the same time, with the special structure, it decreases the vibration of the installation; thereby, all the sounds that caused by vibration in the building are prevented.

**1 İç Katman**  
Pürüzsüz yapısıyla üstün bir akış performansı sağlar. Aynı zamanda kimyasal dayanımı sayesinde boru içerisinde oluşacak korozyonu önler. Yüksek su sıcaklıklarına dayanıklıdır.

**1 Inner Layer**  
It gives excellent flow performance with smooth structure. Also, it prevents corrosion in the pipe with its having chemical resistance. It is resistant to high level water heat.

**2 Orta Katman**  
Yüksek molekül ağırlıktaki yapısı ve özel formülü sayesinde boru içerisinde oluşan ses dalgalarını emerek boru dışına yansımalarını önler.

**2 Middle Layer**  
Because of its having high weight molecular structure and special formula, it absorbs sound waves and prevents to reflect out of the pipe.

**3 Dış Katman**  
Yüksek sıcaklıklara ve darbelere dayanıklıdır.

**3 Outer Layer**  
It is resistant to high level water heat.

### SES NEDİR?

Ses, kulaktan beyine bir duyu olup kulak zarı tarafından algılanan gaz, sıvı ve katı maddelerdeki mekanik titreşimdir. Sesi oluşturan mekanik titreşimler bir frekansa sahiptir. İnsan kulağı 16 Hz (çok düşük ton) ile yaklaşık 16000 Hz (çok yüksek ton) arası frekanslardaki sesleri duyabilir. Frekansı düzgün olmayan sesler gürültüyü oluşturur. Gürültü; hoş gitmeyen, istenmeyen rahatsız edici ses olarak da tanımlanabilir.

### SESİ NASIL ÖLÇERSİNİZ?

Ses şiddetini ölçmek için, Sonometre denilen ölçüm aletleri kullanılır. Sonometre sesin şiddetini desibel (dB) cinsinden verir. (dB) İnsan kulağının en çok hassas olduğu ve yüksek frekansların özellikle vurgulandığı bir ses değerlendirme birimidir. Belirli frekanslara sahip ses dalgaları gaz ve sıvı içinde hareket ederken bir basınç oluşturur. Buna ses basıncı denir. Ses basıncının ölçüm birimi u bar (micro bar)'dır.

### GÜRÜLTÜNÜN İNSANLAR ÜZERİNDEKİ ETKİLERİ

Akustik kirlilik ya da gürültü, diğer kirlilik türlerine göre daha yaygındır. Kişisel ve toplumsal yaşam kalitesinin dönüşmesine neden olur. Bir çevre sorunu ele alındığında, öncelikle gürültünün insan ve toplum sağlığı açısından kabul edilecek en yüksek düzeylerin (gürültü, ölçüt ve limitlerinin) ortaya konması daha sonra incelenen çevredeki mevcut gürültü koşullarının ölçüm ve tahmin yönetmeleri ile belirlenmesi ve bunlara bağlı olarak gürültünün bir sistem içinde kontrol altına alınması çalışmalarının yapılması gerekmektedir.

İnsan sağlığı ve konforu üzerinde çok olumsuz etkileri olan gürültü; yüksek tansiyon, baş ağrısı, huzursuzluk sinirlilik gibi psikolojik ve fizyolojik tesirlere neden olan bir olgudur. Yaşam ortamı içinde oluşan ses ve gürültüler iş verimini düşürür konsantrasyonu bozar, dinlenme ve uykuyu bölebilir. Sürekli etki halinde kalınması ruhsal ve fizyolojik sağlığı bozabilir.

### BİNA İÇLERİNDE SES OLUŞUMU

Temiz su tesisatındaki çap daralmaları, suyun yön değiştirmesi su hızının yüksek olması (Boru çapının uygun seçilmemesi) daralan noktalardan gereken kavitasyon oluşumu sifonlarda boşaltma doldurma elemanlardaki parça ve mekanizmalar ve bunların bağlantılarından boşaltılan sular boru içinde sesi (gürültüyü) oluşturur. Binalar ne kadar yüksek ve ara hatlara bağlanan su kaynakları ne kadar fazla olursa sesin oranı katlamalı olarak artar.

### FARKLI SESLERİN SES BASINÇ SEVİYELERİ

10 dB Duyulabilir kol saati tıklaması.  
15 - 20 dB Sessiz ortam.  
20 - 30 dB Sessiz ortamda fısıldama.  
50 - 60 dB Normal sohbet ortamı.  
60 - 65 dB Büro, alışveriş merkezi gürültüsü.  
70 - 75 dB Cadde gürültüsü.  
90 - 100 dB Yakından geçen tren sesi.  
100 - 110 dB Susturucusuz motorsiklet sesi.  
120 - 140 dB Kalkış halideki uçak.

### WHAT IS SOUND?

Sound is a sense from ear to the brain and a mechanical vibration in gases, liquids and solids sensed by eardrum. Any mechanical vibration creating sound has a frequency. The human ear can hear sounds with frequencies from 16 Hz (very low tone) to approximately 16.000 Hz (very high tone). Any sound with no proper frequency creates noise. Noise may also be defined as an unpleasant, undesired and disturbing sound.

### HOW TO MEASURE SOUND?

To measure sound intensity, measuring instruments called sonometers are used. Sonometer indicates sound intensity in decibels (dB). (dB) is a unit of sound intensity to which the human ear is sensitive the most and where high frequencies are particularly emphasized. The sound waves with certain frequencies create a pressure moving in a gas or liquid, which is called sound pressure. The unit of measurement of sound pressure is microbar ( $\mu$ b).

### EFFECTS OF NOISE ON HUMANS

Acoustic pollution or noise is more common than the other types of pollution. They cause the quality of personal or social life to be transformed. When dealing with an environmental issue, first the maximum limits of noise acceptable for the human and social health (noise criteria and limits) should be demonstrated, and then the existing noise circumstances in the environment examined should be determined by measurement and estimation and therefore the studies to control noise in a system should be conducted. Noise that has highly adverse effects on the human health and comfort may lead to psychological and physiological effects such as hypertension, headache, restlessness, and nervousness. Sounds and noises created in a habitat may reduce business efficiency, disturb concentration and interrupt resting and sleeping. Continuous exposure might derange the mental and physiological health.

### SOUND FORMATION IN BUILDINGS

Diameter reductions in a fresh water installation, the shift of sound direction, the highness of the water rate (wrong selection of the pipe diameter), the formation of cavitation required from shrinking points, the parts and mechanisms in the flush filling and discharging elements and the water discharged from their connections create sound (noise) in a pipe. The higher the buildings and the more the water supplies connected to the interim lines, the more exponentially the level of a sound increases.

### SOUND PRESSURE LEVELS OF DIFFERENT SOUNDS

0 - 10 dB perceptible arm watch tick  
15 - 20 dB quiet environment  
20 - 30 dB whispering in a quiet environment  
50 - 60 dB natural conversation environment  
60 - 65 dB office and shopping center noise  
70 - 75 dB street noise  
90 - 100 dB nearby train noise  
100 - 110 dB motorcycle noise without muffler  
120 - 140 dB air plane take off

### GÜRÜLTÜ YAPAN EV İÇİ TEKNİK TESİSATLAR

Sıhhi tesisat ve pis su tesisatları, kalorifer, havalandırma ve klima tesisatları, çamaşır makinası - ortak yıkama tesisatları, sabit mutfaklar - buzdolapları, sabit olmayan ev aletleri - (elektrik süpürgesi) armatürler.

### INDOOR TECHNICAL INSTALLATIONS MAKING NOISE

Sanitary installations and wastewater installations, radiators, ventilation and air-conditioning systems, washing machines, common washing installations, stationary kitchens - refrigerators, non-stationary home appliances (vacuum cleaners), fittings.

#### 1) Hava Yolu İle

Hava yolu ile yayılan ses dalgaları ortam içerisinde basınç oluşturmakta, çarptığı cisimler ve yüzeylerde titreşim meydana getirmektedir.

Üç katlı SILENZIO orta katlarında kullanılan yüksek molekül ağırlığındaki özel formül bu basıncı absorbe edip boru dışına çıkmasını engeller.

#### 1) By Air

Sound waves spreading in the air create pressure in the environment and vibration in the objects and surfaces they hit.

The special high molecular weight formula used in the middle layers of the three-layer SILENZIO absorbs that pressures and prevents it from being reflected outside the pipe.

### ATIK SU SİSTEMLERİNDE SES OLUŞUMU

Atık su sistemlerinde suyun atık su borusu içerisinde oluşturduğu ses düzensiz bir gürültü olarak iki şekilde ortama iletilir.

### FORMATION OF SOUND IN WASTEWATER SYSTEMS

The sound created in the water pipe by water in wastewater systems is transmitted as unstable noise to the environment in two ways.

#### 2) Temas Yolu İle

Atık su tesisatlarında, pis su ve atığın boru giderine çarpması neticesinde boru sisteminde titreşimler meydana gelmektedir. Bu titreşimler temas yolu ile tesisatın bulunduğu duvar üzerine aktarılır.

Temas yolu ile oluşan ses SILENZIO'nun özel moleküler yapısı sayesinde büyük oranda absorbe edebilir.

#### 2) With Contact

In wastewater installations, wastewater and waste hitting the pipe wall creates vibrations in the pipe system. Those vibrations are transmitted with contact onto the wall where the installation is.

The sound created with contact is absorbed to a great extent with SILENZIO's special molecular structure.

## PIYASADA BULUNAN DİĞER BORULARIN SES DEĞERLERİ



15 dB (A) = Atık Su Sisteminizde ulaşabileceğiniz ses değeri  
SILENZIO SES GEÇİRMEYEN BORU SİSTEMİ ile insan kulağının  
duyabileceği en alt seviyeye yakın akustik değerler elde edilmektedir.

## DIN 4109 ve VDI DİREKTİF 4100 YÖNETMELİĞİNE GÖRE SES GEÇİRMEZLİK

DIN EN 14366 Ya göre Ses geçirmezlik ölçümleri Fraunhofer Yapıfiziği Enstitüsü		Boru Sistemi SILENZIO			
Volum akımı (1/s)		0,5	1	2	4
Tüm kelepçeler açık db (A)		3	6	11	18
Tüm kelepçeler kapalı db (A)	Karakteristik gövde ses göstergisi LSCA db (A)	3	9	12	16

**Test odası ve yetkili alman teknik enstitülerinde gürültü seviyesi test ile ilgili tesis tasarımı.**

1. DN/OD 110/87 T-parça
2. 2x45 dirsek ve 250mm boru
3. Düz sabitleme
4. Ayaklı sabitleme
5. Kayar sabitleme
6. Deşarj

Arka giriş ve arka bodrum  
(Ölçüm ve kayıt odaları)  
Tesisat duvarı: 115mm kum-kireç tuğlası  
(220 kg/m<sup>2</sup>)

Su deşarjı: WC den sürekli olarak  
Q = 0.5 | /sn (30 | / dak)  
Q = 1.0 | / sn (60 | / dak)  
Q = 2.0 | / sn (120 | / dak)  
Q = 4.0 | / sn (240 | / dak)

**Test room and plant design related to the test of noise level at authorized German technical institutes**

1. DN/OD 110/87 T-piece
2. 2x45 bracket and 250mm pipe
3. Straight fixation
4. Pedestal fixation
5. Sliding fixation
6. Discharge

Back entrance and back basement  
(Measuring and recording rooms)  
Installation wall: 115 mm sand-lime brick  
(220 kg/m<sup>2</sup>)

Water discharge: Continuously from WC  
Q = 0.5 | /sec (30 | / min)  
Q = 1.0 | / sec (60 | / min)  
Q = 2.0 | / sec (120 | / min)  
Q = 4.0 | / sec (240 | / min)

Fraunhofer Institut für Bauphysik

**Table 1** SANICA A.S.; acoustic measurements according to DIN 4109 and EN 14366 of November 10, 2011. Sound pressure levels measured in the installation test facility. Test object was the wastewater installation system "SANICA SILENZIO: 110 x 3.2" (manufacturer SANICA A.S.). The wastewater system consisted of straight plastic pipes and fittings (size OD 110 mm) and standard steel pipe clamps "xxxxx" by xxxxxx.

Flow rate (l/s)	Wastewater system "SANICA SILENZIO: 110 x 3.2" with pipe clamps "xxxxx"			
	0.5	1.0	2.0	4.0
Installation sound level L <sub>1</sub> [dB(A)] measured in the basement test-room UG front *)	48,2	52,0	53,8	55,8
Installation sound level L <sub>2</sub> [dB(A)] measured in the basement test-room UG rear *)	17,7	22,4	24,7	28,7
Airborne sound pressure level L <sub>1,2</sub> [dB(A)] *)	48,2	52,0	53,8	55,8
Structure-borne sound characteristic level L <sub>1,2</sub> [dB(A)] *)	16,1	20,9	22,8	26,6

\*) Evaluation according to DIN 4109  
\*) Evaluation according to DIN 14366

**Table 1a** as with table 1, but with rounded values

Flow rate (l/s)	Wastewater system "SANICA SILENZIO: 110 x 3.2" with pipe clamps "xxxxx"			
	0.5	1.0	2.0	4.0
Installation sound level L <sub>1</sub> [dB(A)] measured in the basement test-room UG front *)	48	52	54	56
Installation sound level L <sub>2</sub> [dB(A)] measured in the basement test-room UG rear *)	18	22	24	28
Airborne sound pressure level L <sub>1,2</sub> [dB(A)] *)	48	52	54	56
Structure-borne sound characteristic level L <sub>1,2</sub> [dB(A)] *)	16	21	23	27

\*) Evaluation according to DIN 4109  
\*) Evaluation according to EN 14366

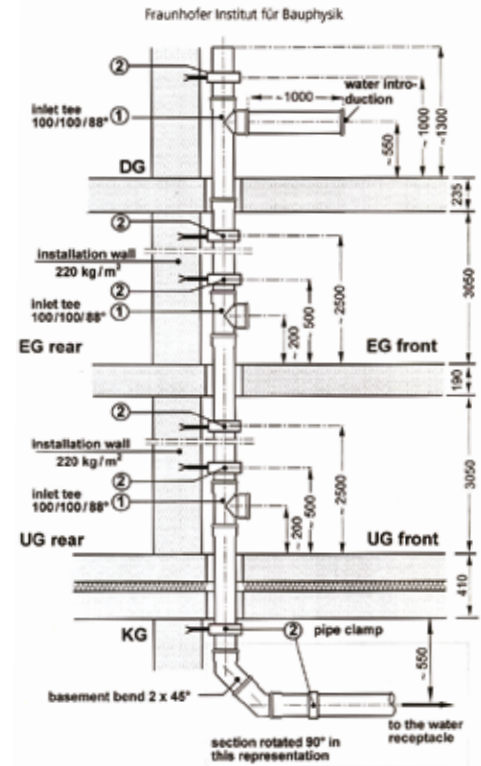

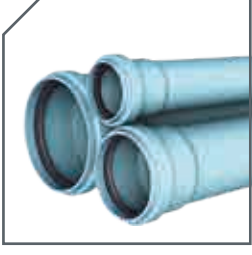

SESSİZ ATIK SU BORUSU  
SILENZIO WASTE WATER PIPES

Kod Code	Çap / Boy Diameter / Length (mm)	Et Kalınlığı Thickness (mm)	Paket Miktarı Bundle / Sack Quantity (pcs)	Ambalaj Tipi Packing Type	Fiyat Price (TL)
503-052000	50/150	2.2	150	Çuval Sack	7,41
503-052002	50/250	2.2	100	Çuval Sack	9,36
503-052004	50/500	2.2	50	Çuval Sack	13,46
503-052006	50/1000	2.2	10	Bağ Bundle	22,51
503-052008	50/2000	2.2	10	Bağ Bundle	43,90
503-052010	50/3000	2.2	10	Bağ Bundle	67,09
503-052012	50/6000	2.2	5	Bağ Bundle	128,69
503-052014	75/150	2.4	70	Çuval Sack	13,53
503-052016	75/250	2.4	50	Çuval Sack	17,57
503-052018	75/500	2.4	25	Çuval Sack	24,19
503-052020	75/1000	2.4	10	Bağ Bundle	36,74
503-052022	75/2000	2.4	10	Bağ Bundle	69,20
503-052024	75/3000	2.4	10	Bağ Bundle	101,46
503-052026	75/6000	2.4	3	Bağ Bundle	187,32
503-052028	110/150	3.2	35	Çuval Sack	19,02
503-052030	110/250	3.2	25	Çuval Sack	24,45
503-052032	110/500	3.2	12	Çuval Sack	35,46
503-052034	110/1000	3.2	6	Bağ Bundle	61,67
503-052036	110/2000	3.2	6	Bağ Bundle	115,72
503-052038	110/3000	3.2	6	Bağ Bundle	167,43
503-052040	110/6000	3.2	3	Bağ Bundle	325,72
503-052042	125/150	3.2	25	Çuval Sack	22,21
503-052044	125/250	3.2	15	Çuval Sack	32,73
503-052046	125/500	3.2	10	Çuval Sack	55,85
503-052048	125/1000	3.2	3	Bağ Bundle	91,43
503-052050	125/2000	3.2	3	Bağ Bundle	173,80
503-052052	125/3000	3.2	3	Bağ Bundle	249,00
503-052054	125/6000	3.2	3	Bağ Bundle	383,69
503-052056	160/150	4.0	15	Çuval Sack	29,41
503-052058	160/250	4.0	9	Çuval Sack	56,06
503-052060	160/500	4.0	5	Çuval Sack	87,31
503-052062	160/1000	4.0	3	Bağ Bundle	133,74
503-052064	160/2000	4.0	3	Bağ Bundle	235,40
503-052066	160/3000	4.0	3	Bağ Bundle	338,31
503-052068	160/6000	4.0	3	Bağ Bundle	535,09



SILENZIO DİRSEK 45°  
SILENZIO 45° ELBOW



Kod Code	Çap Diameter (mm)	Çuval Miktarı Sack Quantity (pcs)	Fiyat Price (TL)
503-062200	50x45	100	7,68
503-062202	75x45	40	13,36
503-062204	110x45	15	20,18
503-062206	125x45	10	48,72
503-062208	160x45	5	87,65

SILENZIO DİRSEK 87°  
SILENZIO 87° ELBOW

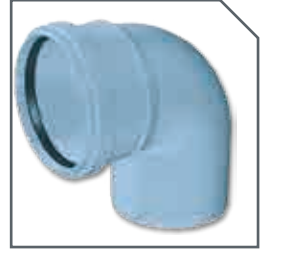

Kod Code	Çap Diameter (mm)	Çuval Miktarı Sack Quantity (pcs)	Fiyat Price (TL)
503-062224	50x87	100	8,50
503-062226	75x87	40	20,06
503-062228	110x87	15	25,60
503-062230	125x87	10	66,28
503-062232	160x87	5	120,62

SILENZIO TEK ÇATAL 45°  
SILENZIO 45° SINGLE BRANCH



Kod Code	Çap Diameter (mm)	Çuval Miktarı Sack Quantity (pcs)	Fiyat Price (TL)
503-062250	50x50x45	50	12,44
503-062252	75x50x45	25	15,78
503-062254	75x75x45	15	16,99
503-062256	110x50x45	10	16,22
503-062258	110x75x45	10	54,46
503-062260	110x110x45	6	65,02

SILENZIO TE ÇATAL 87°  
SILENZIO T BRANCH 87°

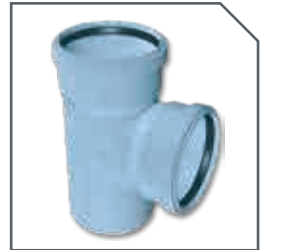

Kod Code	Çap Diameter (mm)	Çuval Miktarı Sack Quantity (pcs)	Fiyat Price (TL)
503-062300	50x50x87	50	31,38
503-062302	75x50x87	30	33,47
503-062304	75x75x87	20	36,11
503-062306	110x50x87	15	50,39
503-062308	110x75x87	10	56,95
503-062310	110x110x87	8	80,97





SILENZIO ÇİFT ÇATAL 45°  
SILENZIO 45° DOUBLE BRANCH

Kod Code	Çap Diameter (mm)	Çuval Miktarı Sack Quantity (pcs)	Fiyat Price (TL)
503-062350	50x50x45	30	21,24
503-062352	75x50x45	20	30,04
503-062354	75x75x45	10	32,66
503-062356	110x50x45	10	48,22
503-062358	110x110x45	5	77,49



SILENZIO İSTAVROZ TE ÇATAL 87°  
SILENZIO 87° CROSS T

Kod Code	Çap Diameter (mm)	Çuval Miktarı Sack Quantity (pcs)	Fiyat Price (TL)
503-062370	110x50x87	10	57,73
503-062372	110x110x87	6	86,16



SILENZIO REDÜKSİYON  
SILENZIO REDUCING SOCKET

Kod Code	Çap Diameter (mm)	Çuval Miktarı Sack Quantity (pcs)	Fiyat Price (TL)
503-062400	75x50	75	15,97
503-062402	110x50	30	24,06
503-062404	110x75	25	25,68
503-062406	125x110	20	37,96
503-062408	160x110	10	52,29
503-062407	160x125	10	52,82



SILENZIO KAYAR MANŞON  
SILENZIO SLIDING COUPLING

Kod Code	Çap Diameter (mm)	Çuval Miktarı Sack Quantity (pcs)	Fiyat Price (TL)
503-062420	50	100	10,94
503-062422	75	50	16,24
503-062424	110	20	34,26

SILENZIO S SIFON  
SILENZIO S SIPHON

Kod Code	Çap Diameter (mm)	Çuval Miktarı Sack Quantity (pcs)	Fiyat Price (TL)
503-062434	110x110x45	5	48,12
503-062436	110x110x87	5	51,51

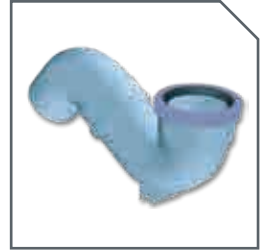

SILENZIO TEMİZLEME TE  
SILENZIO CLEANING T

Kod Code	Çap Diameter (mm)	Çuval Miktarı Sack Quantity (pcs)	Fiyat Price (TL)
503-062442	110	10	118,55



SILENZIO MUF TAPASI  
SILENZIO PLUG

Kod Code	Çap Diameter (mm)	Çuval Miktarı Sack Quantity (pcs)	Fiyat Price (TL)
503-062480	50	500	9,97
503-062482	75	200	12,48
503-062484	110	75	27,72



# SÜPER SESSİZ SUPER SILENT

SÜPER SESSİZ ÜÇ KATLI BORU  
SUPER SILENT THREE LAYERED  
WASTE WATER PIPES



SÜPER SESSİZ BORU  
SUPER SILENT PIPE



Kod Code	Çap Diameter (mm)	Paket Miktarı Bundle Quantity (pcs)	Fiyat Price (TL)
503-072000	50/150	-	27,36
503-072002	50/250	-	35,37
503-072004	50/500	-	46,96
503-072006	50/1000	-	80,75
503-072008	50/2000	-	148,57
503-072010	50/3000	-	206,94
503-072014	75/150	-	31,39
503-072016	75/250	-	37,78
503-072018	75/500	-	50,84
503-072020	75/1000	-	85,92
503-072022	75/2000	-	153,59
503-072024	75/3000	-	221,34
503-072028	110/150	-	46,79
503-072030	110/250	-	54,66
503-072032	110/500	-	81,46
503-072034	110/1000	-	134,43
503-072036	110/2000	-	242,15
503-072038	110/3000	-	353,15
503-072042	125/150	-	71,92
503-072044	125/250	-	93,25
503-072046	125/500	-	132,92
503-072048	125/1000	-	175,07
503-072050	125/2000	-	316,21
503-072052	125/3000	-	432,10
503-072056	160/150	-	93,39
503-072058	160/250	-	106,30
503-072060	160/500	-	132,31
503-072062	160/1000	-	202,36
503-072064	160/2000	-	360,76
503-072066	160/3000	-	535,87
503-072074	200/500	-	238,18
503-072076	200/1000	-	482,82
503-072078	200/2000	-	952,32
503-072080	200/3000	-	1418,79

# SÜPER SESSİZ BORU EK PARÇALARI

## SUPER SILENT PIPE FITTINGS



TE TEK ÇATAL 87,5°  
87,5° T SINGLE BRANCH

Kod Code	Çap Diameter (mm)	Paket Miktarı Bundle Quantity (pcs)	Fiyat Price (TL)
503-082300	50x50 mm	-	41,29
503-082304	75x75 mm	-	66,24
503-082310	110x110 mm	-	153,71
503-082312	125x125 mm	-	255,11



SÜPER SESSİZ REDÜKSİYON  
SUPER SILENT REDUCING SOCKET

Kod Code	Çap Diameter (mm)	Paket Miktarı Bundle Quantity (pcs)	Fiyat Price (TL)
503-082400	75x50 mm	-	31,65
503-082402	110x50 mm	-	52,59
503-082404	110x75 mm	-	59,68
503-082406	125x110 mm	-	67,15
503-082407	160x125 mm	-	131,82
503-082412	160x200 mm	-	202,30



SÜPER SESSİZ KAYAR MANŞON  
SUPER SILENT SLIDING COUPLING

Kod Code	Çap Diameter (mm)	Paket Miktarı Bundle Quantity (pcs)	Fiyat Price (TL)
503-082430	200 mm	-	584,67



TEMİZLEME TE  
SUPER SILENT CLEANING T

Kod Code	Çap Diameter (mm)	Paket Miktarı Bundle Quantity (pcs)	Fiyat Price (TL)
503-082440	75x87,5° mm	-	244,99
503-082442	110x87,5° mm	-	345,49
503-082444	125x87,5° mm	-	585,93



SÜPER SESSİZ DİRSEK 45°  
SUPER SILENT 45° ELBOW

Kod Code	Çap Diameter (mm)	Paket Miktarı Bundle Quantity (pcs)	Fiyat Price (TL)
503-082200	50x45 mm	-	22,61
503-082202	75x45 mm	-	31,92
503-082204	110x45 mm	-	63,75
503-082206	125x45 mm	-	94,77
503-082208	160x45 mm	-	176,73
503-082210	200x45 mm	-	376,94

SÜPER SESSİZ DİRSEK 87,5°  
SUPER SILENT 87,5° ELBOW

Kod Code	Çap Diameter (mm)	Paket Miktarı Bundle Quantity (pcs)	Fiyat Price (TL)
503-082224	50x87,5° mm	-	24,80
503-082226	75x87,5° mm	-	39,25
503-082228	110x87,5° mm	-	74,62
503-082230	125x87,5° mm	-	124,38
503-082232	160x87,5° mm	-	211,78
503-082234	200x87,5° mm	-	474,47



SÜPER SESSİZ TEK ÇATAL 45°  
SUPER SILENT 45° SINGLE BRANCH

Kod Code	Çap Diameter (mm)	Paket Miktarı Bundle Quantity (pcs)	Fiyat Price (TL)
503-082250	50x50 mm	-	46,77
503-082252	75x50 mm	-	61,93
503-082254	75x75 mm	-	75,46
503-082256	110x50 mm	-	93,23
503-082258	110x75 mm	-	114,66
503-082260	110x110 mm	-	181,80
503-082262	125x75 mm	-	174,51
503-082264	125x110 mm	-	186,89
503-082268	125x125 mm	-	311,74
503-082272	160x110 mm	-	329,50
503-082278	200x110 mm	-	639,55
503-082282	200x160 mm	-	815,38
503-082284	200x200 mm	-	861,20



SÜPER SESSİZ SOMUNLU KELEPÇE  
SUPER SILENT CLAMP WITH NUT

Kod Code	Çap Diameter (mm)	Paket Miktarı Bundle Quantity (pcs)	Fiyat Price (TL)
702-082461	50 mm	-	9,51
702-082463	75 mm	-	18,04
702-082465	110 mm	-	23,76
702-082467	125 mm	-	30,74
702-082469	160 mm	-	33,13



SÜPER SESSİZ TRİFONLU KELEPÇE  
SUPER SILENT CLAMP

Kod Code	Çap Diameter (mm)	Paket Miktarı Bundle Quantity (pcs)	Fiyat Price (TL)
702-082460	50 mm	-	9,51
702-082462	75 mm	-	18,04
702-082464	110 mm	-	23,76
702-082466	125 mm	-	30,74
702-082468	160 mm	-	33,13



SÜPER SESSİZ MUF TAPASI  
SUPER SILENT PLUG

Kod Code	Çap Diameter (mm)	Çuval Miktarı Sack Quantity (pcs)	Fiyat Price (TL)
503-062481	50	500	29,92
503-062486	75	200	37,44
503-062487	110	75	83,14





# Boru Pipe

ALTYAPI SİSTEMLERİ (PE)  
(PE) INFRASTRUCTURE SYSTEMS







Toplam alan  
Total area  
**178.000 m<sup>2</sup>**

Kapalı alan  
Covered area  
**45.000 m<sup>2</sup>**

Elazığ / TURKEY

Elazığ fabrikamız ülkemizin özellikle doğu bölgelerindeki alt yapı konusundaki eksiklerin giderilmesi ve bölgede istihdam sağlanması için 2011 yılında üretime başlamıştır. 178.000 m<sup>2</sup> açık alanı 45.000 m<sup>2</sup> kapalı alanı bölgedeki en büyük ve en modern boru tesisidir. Stratejik bir konumda olması nedeni ile komşu ülkelere ihracat yapma açısından ülkemize ciddi oranda katma değer sağlamaktadır. Elazığ Fabrikamızda üretimini yaptığımız ürün grubumuz beş ana kalemden oluşmaktadır.

- PE 100, PE 80, PE 63 PE 32 Temiz Su Boruları, PE 80 Doğalgaz Boruları.
- Koruge Borular ve Ek Parçaları (SN-4,SN-8)
- PVC Temiz Su Boruları.
- PVC Atık Su Boru ve Ek Parçaları
- Filtreli ve Filtresiz Drenaj Boruları

Our factory in Elazığ, a city in the South East of Turkey, established in 2011 in order to overcome the shortage of infrastructure pipe production in this region, also to allow employments to the population there. This factory is the largest and most modern plant in the region which has 178.000 m<sup>2</sup> of open space and 45.000 m<sup>2</sup> covered area.

The strategical location which allow export to neighboring countries provide a significant added value to our country.

This factory has five main items related to pipe production in our group.

- PE 100, PE 80, PE 63 PE 32 Clean Water Pipes, PE 80 Natural Gas Pipes.
- Corrugated pipe and Fittings (SN-4, SN-8)
- PVC Clean Water Pipes.
- PVC Sewage Water Pipe and Fittings.
- Drainage Pipe with Filter and without Filter.

PE 100 RC TEMİZ SU BORULARI  
PE 100 RC POTABLE WATER PIPES

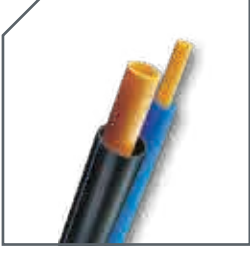

PE 100 PN-10 (SDR 17)

Çap Diameter (mm)	Kalınlık Thickness (m)	Ağırlık Weight (kg)
20	2.0	0,11
25	2.0	0,15
32	2.0	0,19
40	2.4	0,30
50	3.0	0,45
63	3.8	0,72
75	4.5	1,02
90	5.4	1,46
110	6.6	2,17
125	7.4	2,76
140	8.3	3,46
160	9.5	4,52
180	10.7	5,71
200	11.9	7,05
225	13.4	8,93
250	14.8	11,00
280	16.6	13,70
315	18.7	17,40
355	21.1	22,10
400	23.7	28,00
450	26.7	35,40
500	29.7	43,80
560	33.2	54,80
630	37.4	69,40
710	42.1	88,00
800	47.4	112,00
900	53.3	141,00
1000	59.3	175,00
1200	70.6	247,06

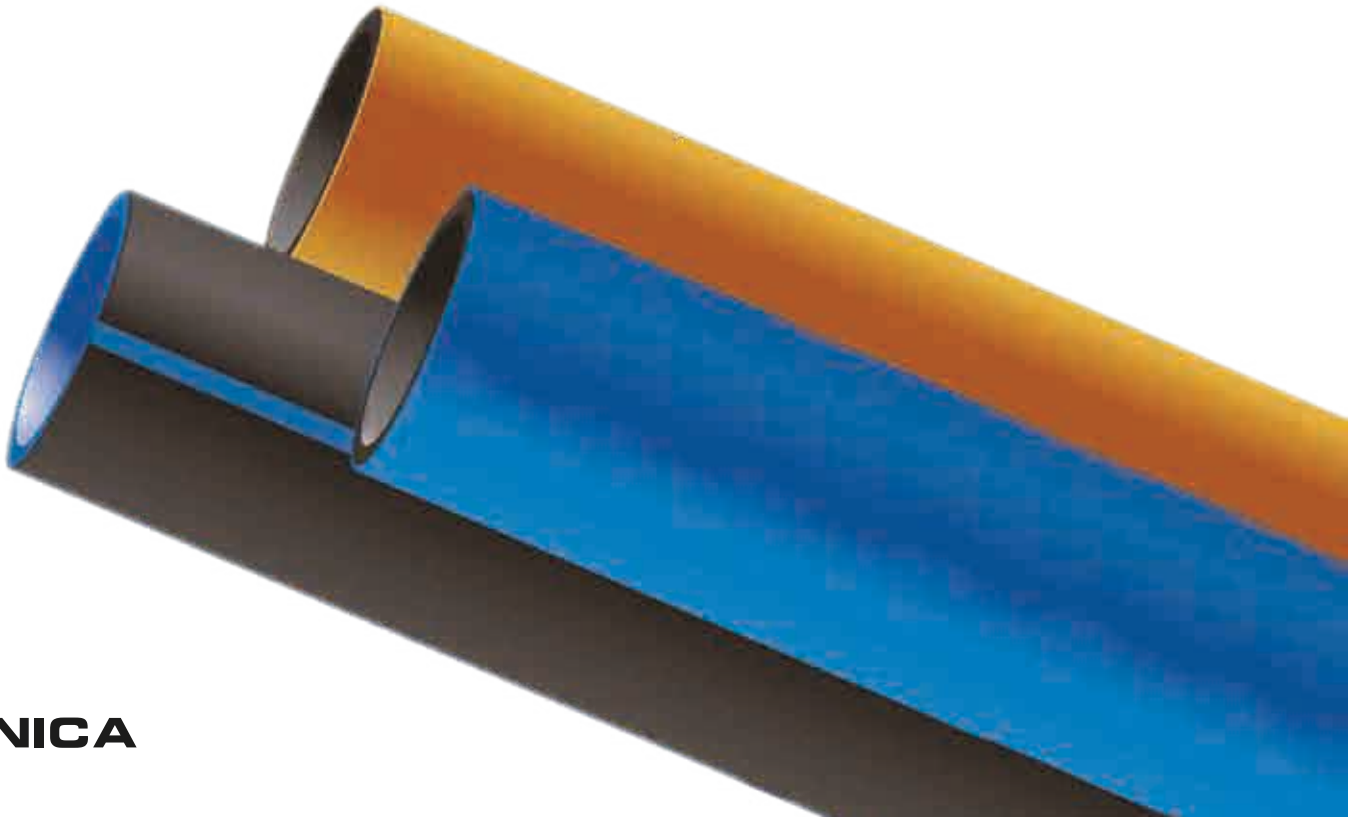

PE 100 RC BORULARI  
PE 100 RC PIPES

PE 100 PN-16 (SDR 11)

Çap Diameter (mm)	Kalınlık Thickness (m)	Ağırlık Weight (kg)
20	2.0	0.11
25	2.3	0.17
32	3.0	0.27
40	3.7	0.43
50	4.6	0.67
63	5.8	1.05
75	6.8	1.47
90	8.2	2.12
110	10.0	3.14
125	11.4	4.08
140	12.7	5.08
160	14.6	6.67
180	16.4	8.42
200	18.2	10.40
225	20.5	13.10
250	22.7	16.20
280	25.4	20.30
315	28.6	25.60
355	32.2	32.50
400	36.3	41.30
450	40.9	52.30
500	45.4	64.50
560	50.8	80.80
630	57.2	102.00
710	64.5	130.00
800	72.7	163.86
900	81.8	207.41
1000	90.9	256.09
1200	109.1	368.83

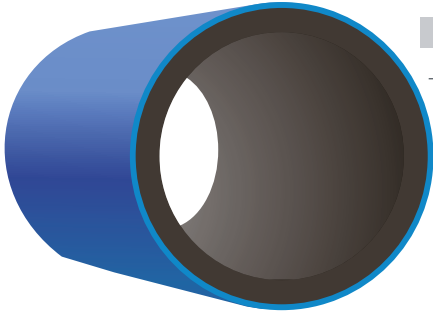
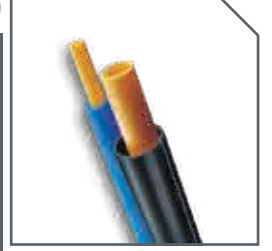

PE 100 RC BORU

Yaklaşık. %10 (PE 100 RC, renkli)

Yaklaşık. %90 (PE 100 siyah)

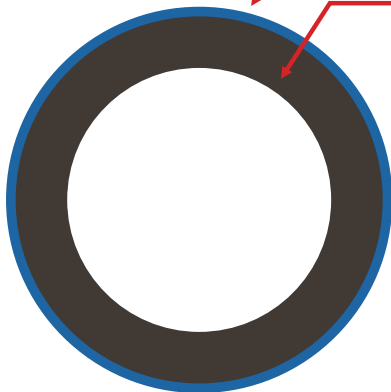

İki katmanlı PE boru  
PE 100 RC-PE 100

İki katmanlı PE boru  
PE 100 -PE 100 RC

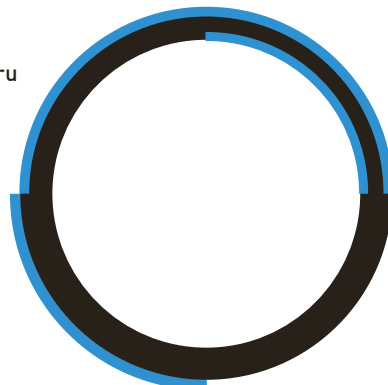

Üç katmanlı boru  
PE 100 RC-PE 100 - PE 100 RC

PE 100 RC



PE 32 TEMİZ SU BORULARI  
PE 32 POTABLE WATER PIPES

PE 32 PN-6 Atm

Kod Code	Çap Diameter (mm)	Paket Miktarı Coil Length (m)	Fiyat Price (USD)/m
502-1063220	20	100 m kangal	0,97
502-1063225	25	100 m kangal	1,40
502-1063232	32	100 m kangal	2,27
502-1064040	40	100 m kangal	3,50
502-1065050	50	100 m kangal	5,40
502-1066363	63	100 m kangal	8,40
502-1006757	75	100 m kangal	11,75



PE 32 PN-10 Atm

Kod Code	Çap Diameter (mm)	Paket Miktarı Coil Length (m)	Fiyat Price (USD)/m
502-1103220	20	100 m kangal	1,45
502-1103225	25	100 m kangal	2,05
502-1103232	32	100 m kangal	3,15
502-1104040	40	100 m kangal	4,75
502-1105050	50	100 m kangal	7,45
502-1106363	63	100 m kangal	11,60
502-1107575	75	100 m kangal	18,00



ÇOKLAYICI BORULAR  
CABLE PROTECTION PIPES

Kod Code	Renk Color	Çap Diameter (mm)	Boru Boyu Pipe Length (m)	Fiyat Price (USD)/m
502-1403232	Siyah Black	40x32x32	200 m kangal	5,70
502-3403232	Turuncu Orange	40x32x32	200 m kangal	6,35
502-1503232	Siyah Black	50x32x32	200 m kangal	6,20
502-3503232	Turuncu Orange	50x32x32	200 m kangal	6,70
502-2403232	Siyah Black	40x40	200 m kangal	6,20
502-5403232	Turuncu Orange	40x40	200 m kangal	6,70





PE 80 DOĞALGAZ BORULARI  
PE 80 NATURAL GASS PIPES



SDR 26  
SDR 26

Kod Code	Çap Diameter (mm)	Kalınlık Thickness (mm)	Ağırlık Weight (kg)	Paket Miktarı Box Quantity (m)
505-08026063000	63	2.5	0.48	4m - 8m - 11.8m - 13.5m
505-08026075000	75	2.9	0.66	4m - 8m - 11.8m - 13.5m
505-08026090000	90	3.5	0.95	4m - 8m - 11.8m - 13.5m
505-08026110000	110	4.2	1.40	4m - 8m - 11.8m - 13.5m
505-08026125000	125	4.8	1.82	4m - 8m - 11.8m - 13.5m

SDR 17.6 / PN 6 ATM



Kod Code	Çap Diameter (mm)	Kalınlık Thickness (m)	Ağırlık Weight (kg)	Paket Miktarı Box Quantity (kg)
505-08018063000	63	3.6	0.68	4m - 8m - 11.8m - 13.5m
505-08018075000	75	4.3	0.97	4m - 8m - 11.8m - 13.5m
505-08018090000	90	5.2	1.41	4m - 8m - 11.8m - 13.5m
505-08018110000	110	6.3	2.08	4m - 8m - 11.8m - 13.5m
505-08018125000	125	7.1	2.66	4m - 8m - 11.8m - 13.5m

SDR 17 / PN 6 ATM



Kod Code	Çap Diameter (mm)	Kalınlık Thickness (m)	Ağırlık Weight (kg)	Paket Miktarı Box Quantity (kg)
505-08017040000	40	2.4	0.29	4m - 8m - 11.8m - 13.5m
505-08017050000	50	3.0	0.45	4m - 8m - 11.8m - 13.5m
505-08017063000	63	3.8	0.72	4m - 8m - 11.8m - 13.5m
505-08017075000	75	4.5	1.01	4m - 8m - 11.8m - 13.5m
505-08017090000	90	5.4	1.46	4m - 8m - 11.8m - 13.5m
505-08017110000	110	6.6	2.17	4m - 8m - 11.8m - 13.5m
505-08017125000	125	7.4	2.77	4m - 8m - 11.8m - 13.5m

SDR 11 / PN 10 ATM



Kod Code	Çap Diameter (mm)	Kalınlık Thickness (m)	Ağırlık Weight (kg)	Paket Miktarı Box Quantity (kg)
505-08011016000	16	3.0	0.13	100m - 200m
505-08011020000	20	3.0	0.17	100m - 200m
505-08011025000	25	3.0	0.21	100m - 200m
505-08011032000	32	3.0	0.28	100m - 200m
505-08011040000	40	3.7	0.43	100m - 200m
505-08011050000	50	4.6	0.67	100m - 200m
505-08011063000	63	5.8	1.06	100m - 200m
505-08011075000	75	6.9	1.50	100m - 200m
505-08011090000	90	8.2	2.14	100m - 200m
505-08011110000	110	10.0	3.18	100m - 200m
505-08011125000	125	11.4	4.12	100m - 173m
505-08011140000	140	12.70	5.14	6m-13,5m
505-08011160000	160	14.60	6.75	6m-13,5m
505-08011180000	180	16.40	8.53	6m-13,5m
505-08011200000	200	18.20	10.52	6m-13,5m
505-08011225000	225	20.50	13.32	6m-13,5m
505-08011250000	250	22.70	16.40	6m-13,5m

**PVC BASINÇLI  
TEMİZ SU BORUSU**

**PVC PRESSURE  
CLEAN WATER PIPE**



[www.sanica.com.tr](http://www.sanica.com.tr)



6 ATÜ PVC TEMİZ SU BORULARI

6 ATU PVC PRESSURE CLEAN WATER PIPES

Kod Code	Çap Diameter (mm)
503-232005	50
503-232006	63
503-232007	75
503-232009	90
503-232011	110
503-232012	125
503-232014	140
503-232016	160
503-232020	200
503-232022	225
503-232025	250
503-232028	280
503-232031	315
503-232035	355
503-232040	400

10 ATÜ PVC TEMİZ SU BORULARI

10 ATU PVC PRESSURE CLEAN WATER PIPES

Kod Code	Çap Diameter (mm)
503-232105	50
503-232106	63
503-232107	75
503-232109	90
503-232111	110
503-232112	125
503-232114	140
503-232116	160
503-232120	200
503-232122	225
503-232125	250
503-232128	280
503-232131	315
503-232135	355
503-232140	400

16 ATÜ PVC TEMİZ SU BORULARI

16 ATU PVC PRESSURE CLEAN WATER PIPES

Kod Code	Çap Diameter (mm)
503-232205	50
503-232206	63
503-232207	75
503-232209	90
503-232211	110
503-232212	125
503-232214	140
503-232216	160
503-232220	200
503-232222	225
503-232225	250
503-232228	280
503-232231	315
503-232235	355
503-232240	400



**PVC BASINÇLI TEMİZ SU BORULARININ İŞLETME BASINÇINA GÖRE  
ET KALINLIĞI VE AĞIRLIK TABLOSU - TS EN 1452-2**

DİS ÇAP mm	DİS ÇAP TOLERANSI	OVALLIK	PN 4 ATM			PN 6 ATM			PN 10 ATM			PN 16 ATM					
			ET KALINLIĞI		AĞIRLIK	ET KALINLIĞI		AĞIRLIK	ET KALINLIĞI		AĞIRLIK	ET KALINLIĞI		AĞIRLIK			
			STANDART (mm)	TOLERANS (mm)	(kg/m)	STANDART (mm)	TOLERANS (mm)	(kg/m)	STANDART (mm)	TOLERANS (mm)	(kg/m)	STANDART (mm)	TOLERANS (mm)	(kg/m)			
20	0,2	0,5															
25	0,2	0,5															
32	0,2	0,5															
40	0,2	0,5															
50	0,2	0,6															
63	0,3	0,8				1,50	0,40	0,329	1,90	0,40	0,525	2,40	0,50	0,517	3,70	0,60	0,775
75	0,3	0,9	1,50	0,40	0,512	2,20	0,50	0,725	3,00	0,60	0,814	3,60	0,60	1,163	4,70	0,70	1,240
90	0,3	1,1	1,60	0,40	0,656	2,70	0,50	1,066	3,60	0,70	1,467	4,30	0,70	1,667	5,60	0,80	1,758
110	0,4	1,4	1,90	0,40	0,963	2,70	0,50	1,311	4,20	0,70	2,010	4,20	0,70	2,010	6,60	0,90	2,470
125	0,4	1,5	2,20	0,45	1,263	3,10	0,60	1,710	4,80	0,70	2,610	4,80	0,70	2,610	7,40	1,00	3,937
140	0,5	1,7	2,50	0,50	1,612	3,50	0,60	2,161	5,40	0,80	3,298	5,40	0,80	3,298	8,30	1,10	4,965
160	0,5	2,0	3,00	0,50	2,198	4,00	0,70	2,823	6,20	0,90	4,314	6,20	0,90	4,314	9,50	1,20	6,468
200	0,6	2,4	3,80	0,60	3,486	4,90	0,70	4,325	7,70	1,00	6,699	7,70	1,00	6,699	11,90	1,40	10,126
225	0,7	2,7	4,30	0,65	4,450	5,50	0,80	5,461	8,60	1,10	8,419	8,60	1,10	8,419	13,40	1,60	12,827
250	0,8	3,0	4,70	0,70	5,417	6,20	0,90	6,838	9,60	1,20	10,440	9,60	1,20	10,440	14,80	1,70	15,748
280	0,9	3,4	5,30	0,75	6,840	6,90	0,90	8,525	10,70	1,30	13,036	10,70	1,30	13,036	16,60	1,90	19,781
315	1,0	3,8	6,00	0,80	8,722	7,70	1,00	10,705	12,10	1,50	16,581	12,10	1,50	16,581	18,70	2,10	25,066
355	1,1	4,3	6,80	0,90	11,200	8,70	1,10	13,830	13,60	1,60	21,005	13,60	1,60	21,005	21,10	2,40	31,872
400	1,2	4,8	7,70	1,00	14,728	9,80	1,20	17,299	15,30	1,80	26,627	15,30	1,80	26,627	23,70	2,60	40,344
450	1,4	5,4															
500	1,5	6,0															
560	1,7	6,8															
630	1,9	7,6															
710	2,0	8,6															
800	2,0	9,6															
900	2,0	21,6															
1000	2,0	24,0															

# KORUGE CORRUGATED

**KANALİZASYON BORUSU ve EK PARÇALARI**  
SEWER PIPE and FITTINGS



**SANICA BORU FABRİKA - ELAZIĞ / TÜRKİYE**  
SANICA PIPE FACTORY - ELAZIĞ / TURKEY

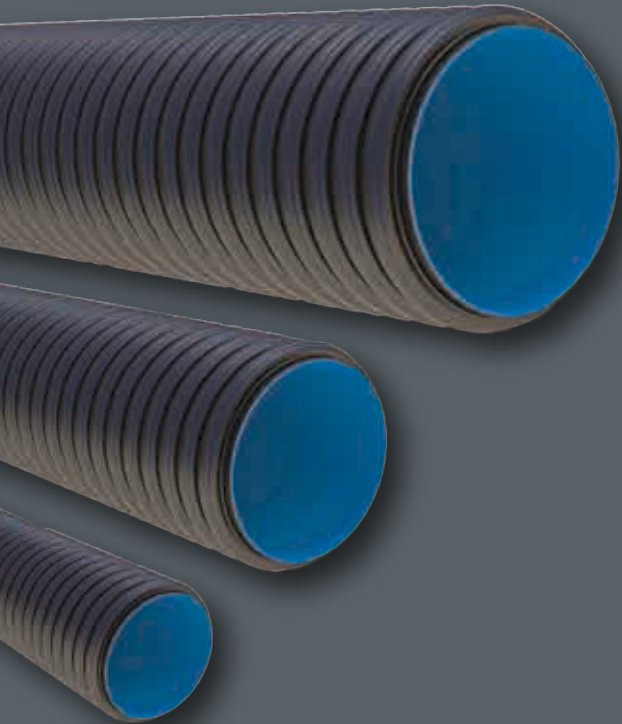



SANIMAX MUFSUZ BORU  
SANIMAX WITHOUT SOCKET

Kod Code	Çap Diameter (mm)	SN (kN/m <sup>2</sup> )	Uzunluk Lenght (m)	Fiyat Price (TL)/m
504-236410	100	4	6-13	6,18
504-236415	150	4	6-13	9,70
504-236420	200	4	6-13	16,24
504-236430	300	4	6-13	34,90
504-236440	400	4	6-13	58,50
504-236450	500	4	6-13	95,25
504-230461	600	4	6-13	154,92
504-230481	800	4	6-13	266,56
504-2304110	1000	4	6-13	466,48
504-230809	100	8	6-13	7,60
504-230819	150	8	6-13	13,56
504-230829	200	8	6-13	19,11
504-230839	300	8	6-13	45,08
504-230849	400	8	6-13	82,32
504-230859	500	8	6-13	119,56
504-230861	600	8	6-13	193,06
504-230881	800	8	6-13	360,64
504-2308101	1000	8	6-13	634,00

SANIMAX KENDİNDEN MUFLU BORU  
SANIMAX PIPE WITH SOCKET

Kod Code	Çap Diameter (mm)	SN (kN/m <sup>2</sup> )	Boru Boyu Pipe Lenght (m)	Fiyat Price (TL)/m
504-230411	200	4	6	16,58
504-230423	300	4	6	35,62
504-230424	400	4	6	59,70
504-230425	500	4	6	97,20
504-230426	600	4	6	158,08
504-230428	800	4	6-13	272,00
504-2304210	1000	4	6-13	476,00
504-230811	200	8	6	19,50
504-230823	300	8	6	46,00
504-230824	400	8	6	84,00
504-230825	500	8	6	122,00
504-230826	600	8	6	197,60
504-230828	800	8	6-13	368,00
504-2308210	1000	8	6-13	648,00

\* DN 800 mm ve DN 1000 mm Kendinden Muflu Koruge Borularımız istenilen boylarda muflu olarak üretilebilmektedir.





KORUGE MUFSUZ BORU  
CORRUGATED PIPE

Kod Code	Çap Diameter (mm)	SN (kN/m <sup>2</sup> )	Uzunluk Lenght (m)	Fiyat Price (TL)/m
504-236410 T	100	4	6-13	8,67
504-236415 T	150	4	6-13	15,46
504-236420 T	200	4	6-13	24,85
504-236430 T	300	4	6-13	62,00
504-236440 T	400	4	6-13	116,20
504-230451 T	500	4	6-13	136,30
504-230461 T	600	4	6-13	220,09
504-230481 T	800	4	6-13	411,13
504-2304110 T	1000	4	6-13	722,76
504-230809 T	100	8	6-13	9,12
504-230819 T	150	8	6-13	16,27
504-230829 T	200	8	6-13	26,10
504-230839 T	300	8	6-13	65,10
504-230849 T	400	8	6-13	122,00
504-230859 T	500	8	6-13	143,47
504-230861 T	600	8	6-13	231,67
504-230881 T	800	8	6-13	432,77
504-2308101 T	1000	8	6-13	760,80

KORUGE KENDİNDEN MUFLU BORU  
CORRUGATED PIPE WITH SOCKET

Kod Code	Çap Diameter (mm)	SN (kN/m <sup>2</sup> )	Boru Boyu Pipe Lenght (m)	Fiyat Price (TL)/m
504-230411 T	200	4	6	25,30
504-230423 T	300	4	6	63,40
504-230424 T	400	4	6	118,50
504-230425 T	500	4	6	139,08
504-230426 T	600	4	6	225,27
504-230428 T	800	4	6-13	419,52
504-2304210 T	1000	4	6-13	738,72
504-230811 T	200	8	6	26,60
504-230823 T	300	8	6	66,40
504-230824 T	400	8	6	124,40
504-230825 T	500	8	6	146,40
504-230826 T	600	8	6	237,12
504-230828 T	800	8	6-13	441,60
504-2308210 T	1000	8	6-13	777,60

\* DN 800 mm ve DN 1000 mm Kendinden Muflu Koruge Borularımız istenilen boylarda muflu olarak üretilebilmektedir.

KORUGE (Telekom)  
CORRUGATED (Conduit Pipe)

Kod Code	Çap Diameter (mm)	Boru Boyu Pipe Lenght (m)	Fiyat Price (TL)/m
504-230610	100	7	5,99
504-230615	150	7	9,41
504-230620	200	7	15,75





MANŞON  
COUPLING

Kod Code	Çap Diameter (mm)	Fiyat Price (TL)/adet
504-230110	100	3,15
504-230115	150	6,60
504-230120	200	10,65
504-230130	300	24,30
504-230140	400	46,50
504-230150	500	216,00
504-230160	600	405,45
504-230180	800	660,00
504-2301100	1000	840,00

CONTA  
GASKET

Kod Code	Çap Diameter (mm)	Fiyat Price (TL)/adet
702-230510	100	0,44
702-230515	150	2,40
702-230520	200	4,00
702-230530	300	8,64
702-230540	400	14,35
702-230550	500	16,10
702-230560	600	35,00
702-230580	800	75,00
702-230610	1000	150,00

C PARÇA PVC ÇIKIŞLI  
C PIECE PVC OUTPUT

Kod Code	Çap Diameter (mm)	Fiyat Price (TL)/adet
702-23031510	150/100	30,00
702-23031515	150/150	43,50
702-23032010	200/100	33,00
702-23032015	200/150	43,50
702-23032020	200/200	73,20
702-23033010	300/100	84,00
702-23033015	300/150	85,53
702-23033020	300/200	94,50
702-23034010	400/100	195,00
702-23034015	400/150	204,00
702-23034020	400/200	209,58



C PARÇA KORUGE ÇIKIŞLI  
C PIECE CORRUGATED OUTPUT

Kod Code	Çap Diameter (mm)	Fiyat Price (TL)/adet
504-23021510	150/100	28,50
504-23021515	150/150	42,00
504-23022010	200/100	30,00
504-23022015	200/150	42,00
504-23022020	200/200	69,00
504-23023010	300/100	78,00
504-23023015	300/150	81,00
504-23023020	300/200	84,00
504-23023030	300/300	129,00
504-23024010	400/100	189,00
504-23024015	400/150	195,00
504-23024020	400/200	204,00
504-23024030	400/300	216,00
504-23024040	400/400	300,00

T PARÇASI  
T PIECE

Kod Code	Çap Diameter (mm)	Fiyat Price (TL)/adet
702-232215	150/100	30,00
702-231515	150/150	42,00
702-232220	200/100	33,00
702-232015	200/150	45,00
702-232221	200/200	69,00
702-233010	300/100	78,00
702-230331	300/150	80,00
702-232230	300/200	84,00
702-232330	300/300	126,00
702-234010	400/100	183,00
702-234015	400/150	189,00
702-234020	400/200	195,00
702-234030	400/300	210,00
702-23024040	400/400	285,00

DİRSEK 45°  
45° ELBOW

Kod Code	Çap Diameter (mm)	Fiyat Price (TL)/adet
704-234510	100	20,10
704-234515	150	21,84
704-234520	200	36,30
704-234530	300	70,50
704-234540	400	180,00





**DİRSEK 90°**  
90° ELBOW

Kod Code	Çap Diameter (mm)	Fiyat Price (TL)/adet
704-239010	100	24,00
704-239015	150	25,50
704-239020	200	39,00
704-239030	300	82,50
704-239040	400	210,00

**REDÜKSİYON**  
REDUCER

Kod Code	Çap Diameter (mm)	Fiyat Price (TL)/adet
702-2301510	150/100	28,26
702-2302210	200/100	33,00
702-2302215	200/150	36,00
702-2302310	300/100	61,50
702-2302315	300/150	63,00
702-2302320	300/200	66,00
702-2302410	400/100	135,00
702-2302415	400/150	147,00
702-2302420	400/200	150,00
702-2302430	400/300	165,00

**ADAPTÖR**  
ADAPTOR

Kod Code	Çap Diameter (mm)	Fiyat Price (TL)/adet
702-92321510	150/110	20,31
702-92321516	150/160	25,20
702-92322011	200/110	33,00
702-92322016	200/160	36,00
702-92322020	200/200	43,50
702-92323015	300/150	64,50
702-92233020	300/200	72,90
702-92324016	400/160	135,00
702-92324020	400/200	140,10

# DRENAJ BORULARI

Drainage Pipes

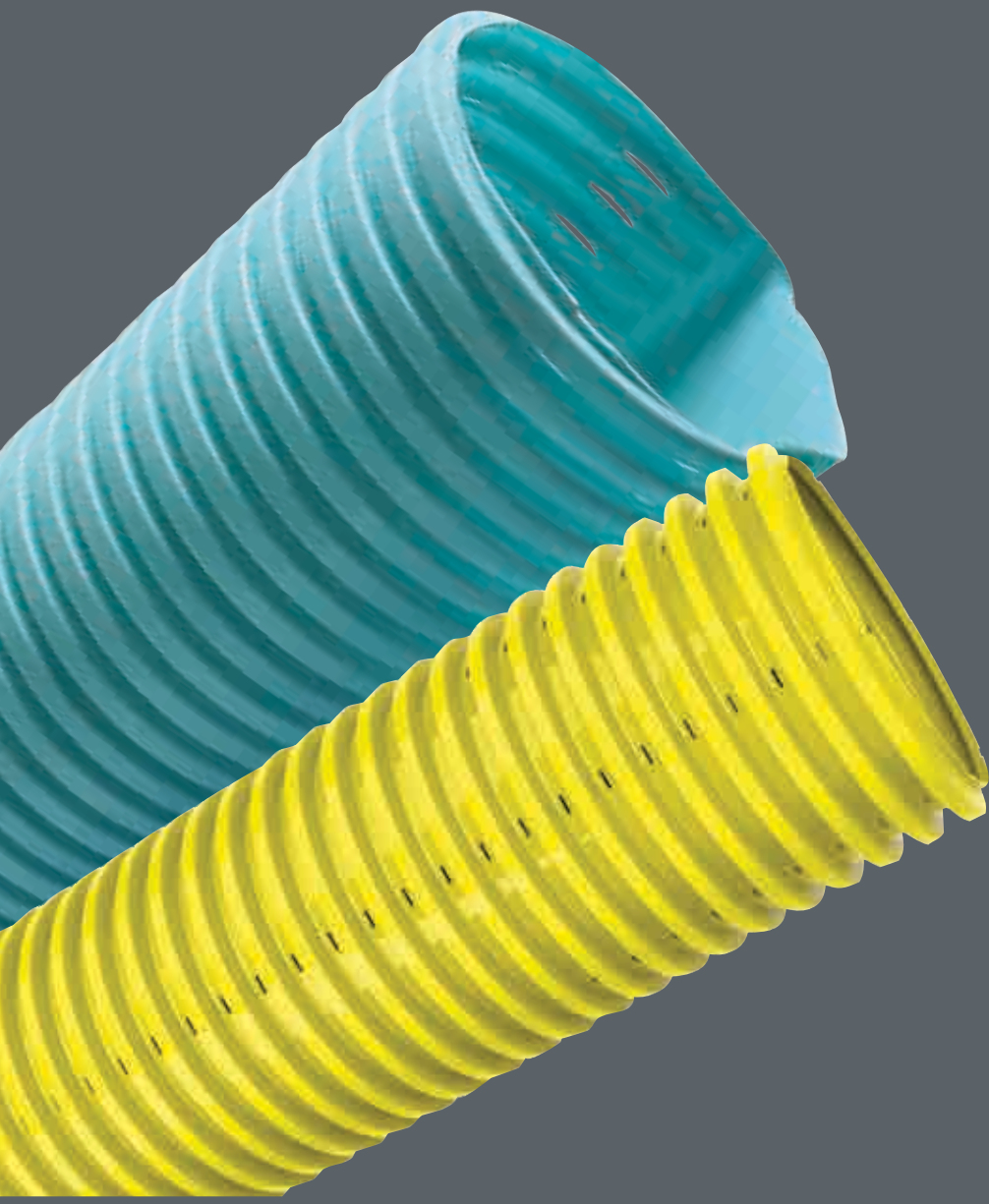

PVC DRENAJ BORULARI  
PVC DRAINAGE PIPES

Kod Code	Çap Diameter (mm)	Boru Boyu Pipe Length (m)	Fiyat Price (TL)/m
506-100080100001	80	100	3,86
506-100100100001	100	100	5,14
506-100125100001	125	50	7,48
506-100160050001	160	50	10,96
506-100200025001	200	25	16,00

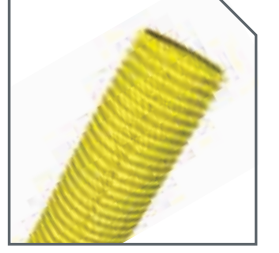

TÜNEL TİPİ PVC DRENAJ BORULARI  
TUNNEL TYPE PVC DRAINAGE PIPES

Kod Code	Çap Diameter (mm)	Boru Boyu Pipe Length (m)	Fiyat Price (TL)/m
506-200160006001	160	6	15,20
506-200200006001	200	6	22,52



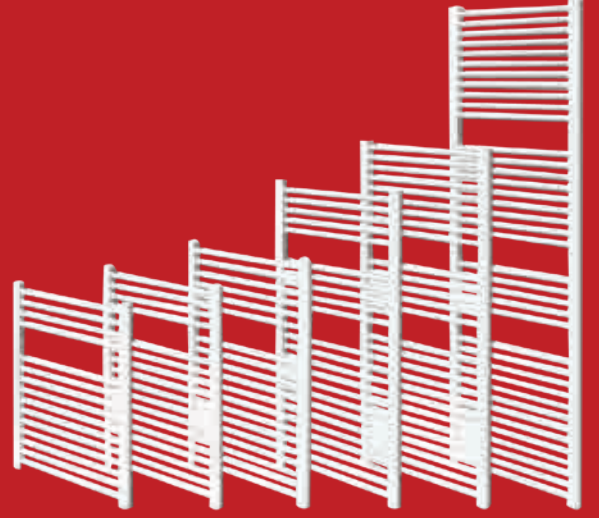

**PANEL RADYATÖR ve HAVLUPAN**  
PANEL RADIATOR and TOWEL WARMERS

TİP 22 PANEL RADYATÖR  
TYPE 22 PANEL RADIATOR

22 PKKP (Panel + Konvektör + Konvektör + Panel)  
22 PKKP (Panel + Convector + Convector + Panel)

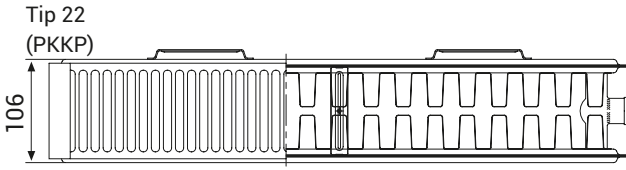

Yükseklik (mm) → Height	300	400	500	600	900
Uzunluk (mm) ↓ Length	Fiyat Price				
400	107,65	121,06	140,50	160,59	223,35
500	131,78	148,75	173,12	198,44	277,40
600	141,45	160,19	186,79	214,65	301,06
700	164,00	186,08	217,34	250,00	351,45
800	175,69	202,94	236,22	274,25	386,43
900	187,77	213,97	250,26	288,75	408,05
1000	204,29	232,97	272,87	315,00	445,47
1100	224,67	256,50	300,66	347,25	491,85
1200	241,77	276,10	323,88	374,11	530,10
1300	258,75	295,68	346,78	400,72	568,39
1400	275,46	314,93	369,51	427,01	605,92
1500	295,13	337,63	396,44	458,36	651,03
1600	308,73	353,60	415,13	480,25	682,21
1700	327,48	375,43	441,07	510,58	725,95
1800	343,48	393,79	462,95	535,94	761,92
1900	364,83	418,28	491,53	568,93	809,24
2000	383,59	443,57	516,29	597,88	849,48
2200	419,12	486,46	564,23	655,75	929,05
2400	457,53	531,36	615,77	715,56	1014,10
2600	496,28	576,83	667,68	776,09	1099,64
2800	534,57	621,36	719,09	835,63	1184,49
3000	575,72	671,84	773,46	901,09	1273,40

TİP 33 PANEL RADYATÖR  
TYPE 33 PANEL RADIATOR

33 PKKPKP (Panel + Konvektör + Konvektör + Panel + Konvektör + Panel)  
33 PKKPKP (Panel + Convector + Convector + Panel + Convector + Panel)

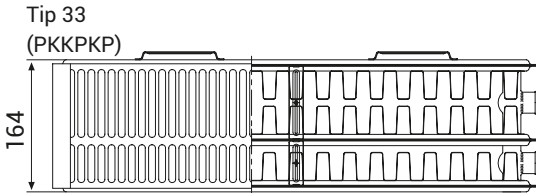

Yükseklik (mm) → Height	300	400	500	600	750	900
Uzunluk (mm) ↓ Length	Fiyat Price					
400	161,94	181,87	219,22	249,11	281,51	343,80
500	202,41	227,32	274,04	311,40	351,89	261,41
600	215,09	241,53	291,18	330,89	373,89	277,75
700	250,93	281,79	339,71	386,03	436,21	324,04
800	286,78	322,05	388,25	441,19	498,53	370,34
900	275,17	309,02	372,53	423,33	478,38	355,37
1000	305,74	343,36	413,93	470,37	531,52	394,84
1100	336,32	377,71	455,33	517,41	584,68	434,34
1200	366,89	412,04	496,70	564,44	637,82	473,81
1300	385,14	432,55	521,42	592,52	669,54	497,38
1400	414,77	465,81	561,53	638,11	721,06	535,64
1500	444,40	499,08	601,65	683,69	772,56	573,91
1600	463,25	520,27	627,17	712,71	805,37	598,27
1700	492,21	552,79	666,38	757,23	855,68	635,65
1800	521,17	585,30	705,59	801,78	906,02	673,04
1900	550,12	617,82	744,78	837,78	956,37	710,43
2000	579,08	650,34	783,99	890,88	1006,69	747,83

TİP 11 PANEL RADYATÖR  
TYPE 11 PANEL RADIATOR

11 PK (Panel + Konvektör)  
11 PK (Panel + Convectör)

Yükseklik (mm) Height	300	400	500	600	750	900
Uzunluk (mm) ↓ Length	Fiyat Price					
400	65,08	73,07	88,10	100,10	113,11	138,14
500	81,33	91,35	110,10	125,13	141,39	172,68
600	86,41	97,05	117,00	132,95	150,24	183,47
700	100,81	113,24	136,51	155,10	175,28	214,05
800	115,23	129,41	155,99	177,27	200,32	244,63
900	110,55	124,17	149,69	170,10	192,21	234,74
1000	122,85	137,98	166,33	189,00	213,58	260,83
1100	135,13	151,77	182,95	207,90	234,93	286,90
1200	147,43	165,57	199,58	226,80	256,28	312,98
1300	154,76	179,90	209,51	238,08	269,03	328,56
1400	166,66	187,17	225,62	256,38	289,74	353,83
1500	178,55	200,54	241,74	274,72	310,43	379,10
1600	186,14	209,06	252,00	286,36	323,59	395,19
1700	197,78	222,13	267,75	304,27	343,81	419,88
1800	209,41	235,19	283,50	322,17	364,06	444,60
1900	221,05	248,24	299,25	336,63	384,29	469,29
2000	232,68	261,30	315,00	362,03	404,51	494,00

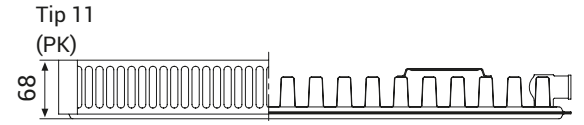

TİP 21 PANEL RADYATÖR  
TYPE 21 PANEL RADIATOR

21 PK (Panel + Konvektör + Panel)  
21 PK (Panel + Convectör + Panel)

Yükseklik (mm) → Height	300	400	500	600	750	900
Uzunluk (mm) ↓ Length	Fiyat Price					
400	97,59	109,63	132,14	150,14	169,68	207,20
500	121,99	137,02	165,16	187,68	212,08	259,01
600	129,64	145,60	175,50	199,42	225,36	275,21
700	151,24	169,85	204,75	232,68	262,92	321,08
800	172,84	194,10	234,00	265,91	300,47	366,94
900	165,85	186,26	224,52	255,15	288,32	352,10
1000	184,27	206,94	249,47	283,50	320,34	391,22
1100	202,70	227,66	274,44	311,85	352,39	430,34
1200	221,12	248,34	299,37	340,20	384,42	469,47
1300	232,13	260,69	314,27	357,13	403,55	492,82
1400	249,98	280,76	338,46	384,60	434,60	530,74
1500	267,85	300,82	362,61	412,05	465,63	568,64
1600	279,22	313,58	378,01	429,56	485,40	592,79
1700	296,67	333,17	401,63	456,40	515,74	629,84
1800	314,10	352,79	425,26	483,26	546,07	666,89
1900	331,56	372,37	448,88	505,28	576,41	703,93
2000	349,03	391,98	472,51	536,94	606,74	740,98
2200	380,03	426,82	514,51	584,67	660,67	806,85
2400	414,58	465,60	561,29	637,82	720,74	880,18
2600	449,13	504,41	608,05	690,97	780,79	953,53
2800	483,68	543,21	654,84	744,11	840,86	1026,88
3000	518,23	582,02	701,59	797,27	900,91	1100,25

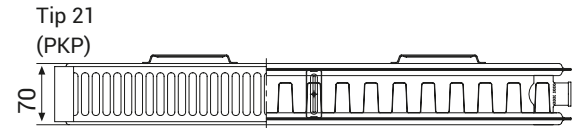



DÜZ HAVLUPANEL - OVAL HAVLUPANEL  
STRAIGHT TOWEL WARMER - OVAL TOWEL WARMER

Model	Genişlik Width (mm)	Yükseklik Height (mm)	Bağlantı Ek Supplement (mm)	Boru Adedi Pipe Quantity (adet/pcs)	Beyaz White		Krom Chrome	
					Düz Straight	Oval Oval	Düz Straight	Oval Oval
400/700	400	700	356	15	84.00	92.40	142.50	156.75
400/800	400	800	356	17	90.29	99.32	148.94	163.83
400/1000	400	1000	356	20	109.33	120.26	179.93	197.92
400/1100	400	1100	356	23	119.76	131.73	197.86	217.65
400/1200	400	1200	356	25	129.56	142.52	214.15	235.56
400/1600	400	1600	356	33	165.00	181.50	279.36	307.29
400/1800	400	1800	356	38	189.07	207.98	313.58	344.94
500/700	500	700	456	15	86.46	95.11	152.40	167.64
500/800	500	800	456	17	95.13	104.65	157.11	172.82
500/1000	500	1000	456	20	115.20	126.72	189.57	208.53
500/1100	500	1100	456	23	126.37	139.01	204.00	224.40
500/1200	500	1200	456	25	136.80	150.48	226.20	248.82
500/1600	500	1600	456	33	178.41	196.25	291.00	320.10
500/1800	500	1800	456	38	200.01	220.01	331.81	364.99
600/700	600	700	556	15	94.80	104.28	159.90	175.89
600/800	600	800	556	17	100.04	110.04	165.29	181.82
600/1000	600	1000	556	20	121.13	133.24	199.16	219.07
600/1100	600	1100	556	23	133.04	146.34	216.00	237.60
600/1200	600	1200	556	25	144.04	158.44	238.20	262.02
600/1600	600	1600	556	33	188.04	206.85	306.00	336.60
600/1800	600	1800	556	38	210.90	231.99	350.04	385.04

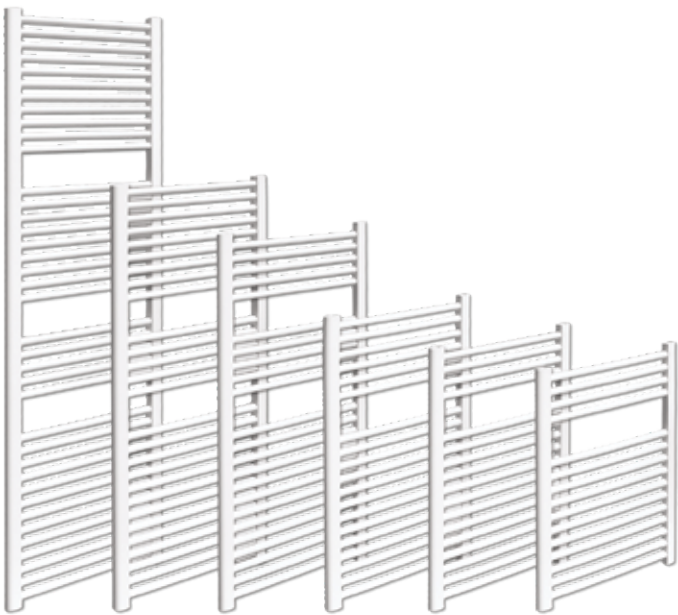









# SANICA

## FABRİKALAR FACTORIES

### Radyatör Fabrikası Radiator Factory

Akhisar Organize Sanayi Bölgesi,  
3. Cadde, No.: 05 P.K.: 45230  
Akhisar / MANİSA - TURKEY

### Banyo Fabrikası - İstanbul Bath Factory - İstanbul

Kavaklı Mahallesi, İstanbul Caddesi,  
No.:10, P.K.:34520 - Kavaklı  
Beylikdüzü / İSTANBUL - TURKEY

### Cam Fabrikası Glass Factory

Akhisar Organize Sanayi Bölgesi,  
3. Cadde, No.: 05 P.K.: 45230  
Akhisar / MANİSA - TURKEY

### Boru Fabrikası - İstanbul Pipe Factory - İstanbul

Kavaklı Mahallesi, İstanbul Caddesi,  
No.:24, P.K.:34520 - Kavaklı  
Beylikdüzü / İSTANBUL - TURKEY

### Boru Fabrikası 2 - İstanbul Pipe Factory 2 - İstanbul

Cihangir Mahallesi, E-5 Yan yol üzeri  
No.:323-1 P.K.:34310  
Avcılar / İSTANBUL - TURKEY

### Boru Fabrikası - Elazığ Pipe Factory - Elazığ

Organize Sanayi Bölgesi, 2.Yol  
No.:25 P.K.:23180  
Yazikonak / ELAZIĞ - TURKEY

### Kombi Fabrikası Wall Hung Gas Boiler Factory

Akhisar Organize Sanayi Bölgesi,  
3. Cadde, No.: 05 P.K.: 45230  
Akhisar / MANİSA - TURKEY

## İLETİŞİM CONTACT

### Merkez Ofis - Central Office

Kavaklı Mahallesi, İstanbul Caddesi,  
No.:10, P.K.:34520 - Kavaklı  
Beylikdüzü / İstanbul  
Telefon : +90 212 855 80 80 (pbx)  
Fax : +90 212 855 80 90  
E-mail : sanica@sanica.com.tr

### SANICA Dış Ticaret A.Ş. (Export)

Kavaklı Mahallesi, İstanbul Caddesi,  
No.:10, P.K.:34520 - Kavaklı  
Beylikdüzü / İstanbul  
Telefon : +90 212 855 80 80 (pbx)  
Fax : +90 212 855 80 90  
E-mail : export@sanica.com.tr

### SANICA Hungary KFT

2051 Biatorbagy Devay Gyula u.9 1/3  
HUNGARY  
Telefon : +36 3045 50570  
Fax : +36 23 820473  
E-mail : barisgur@sanica.com.tr

### SANICA Canada Co.

Sanica Canada Co.,  
8 Mulberry Crescent Toronto  
ON M6C 1N5 CANADA  
Telefon : +1 647 909 64 68  
E-mail : selimperek@sanica.ca

### SANICA England UK

SANICA BUILDING MATERIALS LTD.  
Unit L, Stafford Park, Liston, Sudbury,  
Suffolk, CO10 7HX United Kingdom  
Telefon : 01787275980  
Fax : 01787275788  
E-mail : sales@sanicauk.com



Uygunluk Beyanı







**SANICA**